

CITY OF ROHNERT PARK
CONTRACT DOCUMENTS, SPECIAL PROVISIONS AND
STANDARD SPECIFICATIONS

FOR

GOLF COURSE DRIVE PEDESTRIAN RAMP
IMPROVEMENTS PROJECT
PROJECT NO. 2019-28

BID DUE DATE: THURSDAY, JANUARY 25, 2024, AT 2:00PM



Prepared by
City of Rohnert Park-
Public Works
600 Enterprise Drive
Rohnert Park, CA 94928
(707) 588-3300

CITY COUNCIL

Mayor – Samantha Rodriguez
Vice-Mayor – Susan Hollingsworth Adams
Council Member – Jackie Elward
Council Member – Gerard Giudice
Council Member – Emily Sanborn
City Manager – Marcela Piedra
City Engineer – Vanessa Garrett

Approved: *Vanessa Garrett* 12/12/2023
Vanessa Garrett Date
City Engineer

TABLE OF CONTENTS

	<u>Page</u>
<u>PART 1 - BID DOCUMENTS</u>	
Invitation for Sealed Bids	1-1
Instructions to Bidders	1-3
Bidder's Proposal	1-7
Schedule of Bid Prices	1-9
Addendum Acknowledgment	1-11
Contractor's License Declaration	1-12
List of Subcontractors	1-13
Bid Bond	1-14
Noncollusion Declaration	1-15
Declaration of Eligibility to Contract	1-16
Sample Contract	1-17
Insurance	1-24
Sample Certificate of Insurance and Endorsements	1-25

PART 2 - SPECIAL PROVISIONS

	<u>Paragraph</u>	<u>Page</u>
Project Owner	2.01	2-1
Location and Description of Work	2.02	2-1
Insurance	2.03	2-1
Bonds	2.04	2-4
Liquidated Damages	2.05	2-5
Withdrawals of Proposals	2.06	2-5
Drawings and Specifications	2.07	2-5
Cooperation and Collateral Works	2.08	2-5
Protection and Restoration of Existing Improvements	2.09	2-5
Permits and Licenses	2.10	2-5
Approved Debris Haulers	2.11	2-6
Field Review Prior to Bidding	2.12	2-6
Testing	2.13	2-6
Working Hours and Record Drawings	2.14	2-6
Project Identification Sign	2.15	2-6
Coronavirus Risks and Construction Requirements	2.16	2-7

PART 3—STANDARD SPECIFICATIONS

SECTION 1 - DEFINITIONS AND TERMS

	<u>Paragraph</u>	<u>Page</u>
Definitions and Terms.....	n/a	3-1

SECTION 2 - PROPOSAL REQUIREMENTS AND CONDITIONS

Intent	2.1	3-4
--------------	-----	-----

SECTION 3 - AWARD AND EXECUTION OF CONTRACT

Award of Contract	3.1	3-5
Bid Protests	3.2	3-5
Return of Proposal Guarantees	3.3	3-5
Bonds	3.4	3-6
Execution of Contract	3.5	3-6
Failure to Execute Contract.....	3.6	3-6
 SECTION 4 - SCOPE OF WORK		
Work to be Done by Contractor	4.1	3-8
Final Clean-Up	4.2	3-8
Changes in the Contract - Effect Between Parties	4.3	3-8
Maintenance of Detours	4.4	3-11
Use of Materials Found on the Work	4.5	3-11
 SECTION 5 - CONTROL OF THE WORK		
Authority of City Engineer	5.1	3-13
Plans.....	5.2	3-13
Conformity with Plans	5.3	3-13
Working Drawings	5.4	3-13
Coordination of Plans, Specifications, and Special Provisions	5.5	3-13
Interpretation of Plans and Specifications	5.6	3-14
Superintendence	5.7	3-14
Lines, Grades and Measurements	5.8	3-14
Inspection	5.9	3-15
Unauthorized Work and Defective Work or Materials	5.10	3-15
Methods and Equipment	5.11	3-16
Final Inspection and Acceptance	5.12	3-17
Clean-Up Work	5.13	3-17
 SECTION 6 - CONTROL OF MATERIALS		
City-Furnished Materials	6.1	3-18
Materials to be Furnished by the Contractor	6.2	3-18
Source of Supply and Quality of Materials	6.3	3-18
Water and Electric Power	6.4	3-19
Materials and Workmanship	6.5	3-19
Storage of Materials	6.6	3-19
Samples and Specimens	6.7	3-19
Trade Names and Alternatives	6.8	3-20
Removal of Equipment or Materials	6.9	3-20
Testing of Materials	6.10	3-20
 SECTION 7 - LEGAL RELATIONS AND RESPONSIBILITY		
Laws to be Observed	7.1	3-21
Permits	7.2	3-21
Patent Claims	7.3	3-21
Sanitary Provisions	7.4	3-21
Right of Way and Right of Access	7.5	3-21
Public Convenience and Access	7.6	3-22
Storage of Materials in Public Streets, Roads or Highways	7.7	3-22
Public Safety	7.8	3-22

Street Closures, Detours, Barricades	7.9	3-23
Use of Explosives	7.10	3-23
Preservation of Property	7.11	3-23
Preservation of Monuments	7.12	3-24
Safeguarding Excavations and Structures	7.13	3-24
Emergencies and Responsibility for Damage	7.14	3-24
Disposal of Material Outside of City's Right of Way	7.15	3-25
Contractor's Responsibility for Work	7.16	3-25
City Engineer Cannot Waive Obligations	7.17	3-26
Rights in Land Improvements	7.18	3-26
Personal Liability	7.19	3-26
Repair of Equipment	7.20	3-26
Contractor's Legal Address	7.21	3-27
Cooperation and Collateral Works	7.22	3-27
Utilities	7.23	3-27

SECTION 8 - PROSECUTIONS AND PROGRESS

Subcontracts	8.1	3-31
Assignment	8.2	3-31
Progress of the Work	8.3	3-31
Character of Workmen	8.4	3-31
Temporary Suspension of Work	8.5	3-31
Time of Essence, Liquidated Damages, Extension of Time by City	8.6	3-32
Default By Contractor.....	8.7	3-33
Work at Night.....	8.8	3-33
Maximum Length of Open Trench	8.9	3-33
Limited Acceptance of Work	8.10	3-34

SECTION 9 - MEASUREMENT AND PAYMENT

Measurement for Payment	9.1	3-35
Scope of Payment	9.2	3-35
Deductions from Payments	9.3	3-35
Schedule of Values.....	9.4	3-35
Payments and Monthly Estimates	9.5	3-36
Payment for Extra Work	9.6	3-37
Final Payment	9.7	3-37

SECTION 10 - CLAIMS BY CONTRACTOR

Obligation to File Claims for Disputed Work.....	10.1	3-38
Form and Contents of Claim.....	10.2	3-38
Informal Conference after Claim Submission.....	10.3	3-39
Mediation	10.4	3-39
Other Matters.....	10.5	3-40
Compliance with Statutory Procedures	10.6	3-40

PART 4 – TECHNICAL SPECIFICATIONS

SECTION 12 – TECHNICAL SPECIFICATIONS

Mobilization.....	12.1	4-2
Water Pollution Control Plan.....	12.2	4-3
Construction Surveying.....	12.3	4-4
Construction Staking.....	12.4	4-4
Preservation of Property.....	12.5	4-5
Subgrade Preparation.....	12.6	4-6
Detectable Warning Surface.....	12.7	4-6
Hot Mix Asphalt.....	12.8	4-7
Sawcut Existing Pavement.....	12.9	4-8
Clearing and Grubbing.....	12.10	4-8
Remove Asphalt Concrete Pavement.....	12.11	4-9
Remove Concrete.....	12.12	4-9
Earthwork.....	12.13	4-10
Aggregate Base.....	12.14	4-12
Portland Cement Concrete.....	12.15	4-13
Scarification.....	12.19	4-17
Traffic Striping, Markings, and Raised Pavement Markers.....	12.22	4-18
Striping Removal.....	12.23	4-20
Signs.....	12.24	4-21
Rectangular Rapid Flashing Beacon (RRFB) Assembly.....	12.25	4-21

PART 5 – DRAWINGS

PART 1 - BID DOCUMENTS

INVITATION FOR SEALED BIDS

GOLF COURSE DRIVE PEDESTRIAN RAMP IMPROVEMENTS PROJECT PROJECT NO. 2019-28

Notice is hereby given that on **Thursday, January 25, 2024, at 2:00:00 PM** at 130 Avram Avenue, Rohnert Park, California, the City of Rohnert Park will receive and open sealed bids for the Golf Course Drive Pedestrian Ramp Improvements Project, Project No. 2019-28. Sealed bids shall be dropped off in the secured box to the right of the main doors in front of City Hall before **2:00:00 PM on January 25, 2024**. The work is described generally as **removing asphalt concrete and striping, modifying existing curbs and sidewalks to furnish and install curb ramps, furnishing and installing new striping and signage, and installing rectangular rapid flashing beacon assemblies (RRFBs) at the intersections of Golf Course Drive and Hacienda Circle and Golf Course Drive and Halcyon Place**. The Contractor must have a valid California contractor's license, a Class A license. The Engineer's estimate for this project is **\$190,000**. The Contractor must begin work within fifteen (15) calendar days after official notice by the City Engineer to proceed with the work and must diligently prosecute the same to completion within **180 calendar days** of that Notice.

Under California Labor Code section 1770 *et seq.*, copies of the determination of the Director of the Department of Industrial Relations of the general prevailing rate of per diem wages for each craft, classification and type of workman needed to execute the work are on file in and available to any interested person on request at the Department of Public Works, or on the Internet at <http://www.dir.ca.gov/dlsr/PWD/index.htm>, and are incorporated herein. (Labor Code § 1773.2.) Prevailing wage determinations must also be posted at each job site.

SB 854 (Stat. 2014, Chapter 28) establishes that no contractor or subcontractor may be listed on a bid proposal for a public works project unless registered with the Department of Industrial Relations pursuant to Labor Code section 1725.5 [with limited exceptions from this requirement for bid purposes only under Labor Code section 1771.1(a)]. No contractor or subcontractor may be awarded a contract for public work on a public works project unless registered with the Department of Industrial Relations pursuant to Labor Code section 1725.5. This project is subject to compliance monitoring and enforcement by the Department of Industrial Relations. All contractors and subcontractors must furnish electronic certified payroll records directly to the Labor Commissioner (aka Division of Labor Standards Enforcement). The prime contractor must also post job site notices prescribed by regulation.

Per California Civil Code Section 9550, a payment bond in the amount of 100% of the bid total will be required from the successful bidder for bids exceeding \$25,000. The bond must be provided within 15 calendar days from notice of award and prior to the performance of any work.

A performance bond and bid bond must also be provided for bids exceeding \$25,000.

For any moneys earned by the Contractor and withheld by the City of Rohnert Park to ensure the performance of the contract, the Contractor may, at its request and sole expense, substitute certain securities equivalent to the amount withheld in the form and manner and subject to the terms and conditions provided in the California Public Contracts Code Section 22300.

This notice incorporates by reference the terms, conditions and requirements of the specifications approved by the City, any and all changes or amendments to the specifications and special instructions or special notice issued to or given to prospective bidders.

The City of Rohnert Park makes no representation or warranty of the condition of the jobsite. All prospective bidders are requested to carefully review the plans and specifications and to examine and

conduct tests or otherwise satisfy themselves as to the conditions at the project site, subject to coordination with the office of the Rohnert Park City Engineer.

Except as otherwise indicated in the Instructions to Bidders, bids will be publicly opened, examined and declared on said day and hour and referred to and considered by the City Council at a future City Council meeting. Each bid must be submitted on the bid forms furnished by the City, and each bid must include all the items shown on these forms. Substitute forms may be used if specified in this Notice.

The City reserves the right, in its sole discretion, to reject any or all bids, to re-bid, or to waive inconsequential defects in bidding not involving time, price or quality of the work. The City may reject any and all bids and waive any minor irregularity in the bids.

A copy of the drawings and specifications may be obtained from Draftech for a non-refundable fee. Draftech Blueprinting is located at 1544 Terrace Way, Santa Rosa, CA 95404, phone number 707-578-9442. The planholders list and all addendums shall be issued through Draftech. In order to ensure receipts of addendums, any party interested in the project shall place their information with Draftech. For questions relating to the project, please contact the Department of Public Works at 707-588-3300 or PWProjects@rpcity.org.

Posted Date: December 12, 2023

/s/ SYLVIA LOPEZ CUEVAS

Published Date: December 15 & 29, 2023

City Clerk of the City of Rohnert Park

INSTRUCTIONS TO BIDDERS

The bidder must file its bid with the City Engineer of the City of Rohnert Park, California, using the copy of the Bidder's Proposal and Schedule of Bid Prices furnished with the specifications. These documents must be placed in a sealed envelope marked,

GOLF COURSE DRIVE PEDESTRIAN RAMP IMPROVEMENT PROJECT

PROJECT NO. 2019-28

and addressed to the City Engineer of the City of Rohnert Park, California. Said sealed bids shall be dropped off in the secured box to the right of the main doors in front of City Hall located at 130 Avram Avenue, Rohnert Park, California before 2:00:00 PM on January 25, 2024. The bidder must not file the book of Special Provisions or the Contract Drawings with his bid.

The bidders attention is directed to the schedule of bid prices that requires this project be bid as a unit price contract.

Bid Forms. Each proposal and all bid submittals must conform and be responsive to the Invitation, the Plans, Specifications and Contract documents.

The wording of the proposal and bid submittals must not be changed. Any additions, conditions, limitations, or provisions inserted by the bidder will render the proposal irregular and may cause its rejection. Erasures or interlineations in the proposal or other submittals must be explained or noted over the signature of the bidder.

In case of discrepancy between a unit price and the total price set forth for the unit price item, the unit price shall prevail. Discrepancies between the indicated sum of any column of numerals and the correct sum thereof will be resolved in favor of the correct sum. Discrepancies between written words and figures, or words and numerals, will be resolved in favor of the words.

Prices. All proposals must give the prices proposed, both in writing and in figures in the respective spaces provided, and must be signed by the bidder, who must fill out all blanks in the proposal form as therein required.

Rejection of Bids. Proposals may be rejected if they show any alterations of form, additions not called for, conditional proposals, incomplete proposals, erasures, or irregularities of any kind, excepting that erasures or delineations in the proposal will be accepted as provided under "Bid Forms" above.

When proposals are signed by an agent, other than the officer or officers of a corporation authorized to sign Contracts on its behalf or a member of a co-partnership, a Power of Attorney must be on file with the City prior to opening proposals or must be submitted with the proposal; otherwise, the proposal may be rejected as irregular and unauthorized.

Bid Security. All proposals must be presented under sealed cover and accompanied by one of the following forms of bidder's security: Cashier's check, certified check, or a bidder's bond in form provided herein, executed by an admitted surety insurer authorized to transact business in this State, made payable to the City. Said bidder's bond submitted must be the City's bid bond. The security must be in an amount equal to at least 10 percent of the proposal amount. A proposal must not be considered unless one of the forms of bidder's security is enclosed with it. A bidder's bond will not be accepted unless it has been properly filled out and executed by the surety and by the bidder.

Withdrawal of Bid. Any bid may be withdrawn at any time prior to the time fixed in the public notice for the opening of proposals only by written request for the withdrawal of bid filed with the City Engineer. The request must be executed by the bidder or its duly authorized representative. The withdrawal of a bid does

not prejudice the right of the bidder to file a new bid. This article does not authorize the withdrawal of any bid after the time fixed in the public notice for the opening of bids.

Means of Submittal. Proposals submitted by facsimile and proposals failing to reach the office of the City prior to the date and time set for receipt of same will not be considered.

Opening. Bids will be opened and read at the time and place indicated in the Invitation for Sealed Bids. Bidders and the public are invited to be present.

Multiple Proposals. More than one proposal from an individual, a firm or partnership, a corporation or an association under the same or different names, will not be considered. Reasonable grounds for believing that any bidder is interested in more than one proposal for the work contemplated will cause the rejection of all proposals in which such bidder is interested. If there is reason for believing that collusion exists among the bidders, none of the participants in such collusion will be considered in future proposals. Proposals in which the prices obviously are unbalanced may be rejected.

License Requirement. No proposal will be accepted from a Contractor who is not licensed in accordance with law under the provisions of Division III, Chapter 9, of the Business and Professions Code of the State of California, or from a Contractor that has been deemed irresponsible or unresponsive by the City Council.

Subcontractors. Subcontractors listed by the bidder in accordance with the Special Provisions included herein must be properly licensed under the laws of the State of California for the type of work which they are to perform.

All bidders are hereby notified that they will be required to comply strictly with the provisions of Sections 4100 to 4113, inclusive, of the Public Contract Code of the State of California.

Each bidder must file with its proposal the name and location of place of business, contractor's license number and Department of Industrial Relations registration number, of each Subcontractor who will perform a portion of the Contract work in an amount in excess of one-half of one percent, or in the case of bids for the construction of streets or highways, including bridges, in excess of one-half of one percent (0.5%) of the total bid or \$10,000. In each such instance, the nature and extent of the work to be sublet must be described.

The General Contractor to whom the Contract is awarded will not be permitted, without the written consent of the City, to substitute any person as Subcontractor in place of the Subcontractor designated in the original proposal, or to permit any Subcontract to be assigned or transferred, or to allow it to be performed by anyone other than the original Subcontractor. The City may consent to the substitution of another person as Subcontractor if the original Subcontractor, after having reasonable opportunity so to do, fails or refuses to execute the written Contract presented to it by the General Contractor, when said written Contract is based upon the conditions of the general Contract and complies with the Subcontractor's written proposal.

The failure of the Contractor to specify a Subcontractor for any portion of the Contract work in excess of one-half of one percent of the total Contract price, must be deemed to indicate that the Contractor intends to perform such portion itself. The subletting or Subcontracting of work for which no Subcontractor was designated in the original proposal and which is in excess of one-half of one percent of the total Contract price will be allowed only with the written consent of the City and then only in cases of public emergency or necessity as determined by said City. Under such circumstances, the City is required to establish the facts constituting the emergency or necessity and reduce its findings to a written public record.

Violations of the provisions of these specified sections of the Code must be deemed to be a violation of the Contract, and the City, because of any such violations, must have the right to cancel the Contract. The Contractor, after any such violations, must be penalized to the extent of 20 percent of the amount of the Subcontract involved.

Material. The bidder may be required to furnish, as part of the submittal process, a complete statement of the origin, composition, and manufacture of any or all materials to be used in the construction of the work, together with samples. Such samples may be subjected to the tests provided for in these specifications or in the Special Provisions to determine their quality and fitness for the work.

Additional Requirements. The bidder's attention is directed to Section 3 of the General Provisions for additional proposal requirements and conditions, and information regarding award and execution of the contract. Contractor submitting a bid to the City of Rohnert Park, a public entity, must state, under penalty of perjury, the contractor's license number and the license's expiration date. This information must be entered in the Schedule of Bid Prices. No contractor or subcontractor may be awarded a contract for public work on a public works project unless registered with the Department of Industrial Relations pursuant to Labor Code section 1725.5.

Explanations and Addenda. Any explanation desired by the bidders regarding the meaning or interpretation of the drawings and specifications must be requested in writing and in sufficient time to allow for a written reply to reach them and all other potential bidders before the date and time for submission of bids. Oral explanation or instructions given before award of the contract will not be binding. Any interpretations made will be in the form of an addendum to the specifications or drawings and will be furnished to all bidders and its receipt by the bidder must be acknowledged. Any explanation that makes a material change, addition, or deletion to the terms of the Invitation for Sealed Bids shall be issued no less than 72 hours before the date and time for submission of bids. If an explanation making a material change, addition, or deletion must be issued less than 72 hours before the scheduled date and time for submission of bids, the date and time for submission shall be extended so that a full 72 hours is provided for analysis of the change, addition, or deletion.

Quantity of Work. The quantity of work for the unit price items to be done under the contract as noted in the Bid Schedule is but an estimate and is not to be taken as an expressed or implied statement that the actual quantity of work will correspond to the estimate. The right is reserved to increase or decrease, or to entirely eliminate items from the work if found desirable or expedient. The Contractor will be allowed no claims for anticipated profits, loss of profits, or for any damages of any sort because of any difference between the estimated and the actual quantities of work done.

The quantities given in the schedule, for unit price items, are for comparing proposals and may vary from the actual final quantities. Some quantities may be increased and others may be decreased or entirely eliminated, and no claim must be made against the City for damage occasioned thereby or for loss of anticipated profits, the Contractor being entitled only to compensation for the actual work done at the unit prices proposal.

The City reserves and must have the right to increase or decrease the quantities of work to be performed under a scheduled unit item or to entirely omit the performance thereof and upon decision of the City to so do, the City Engineer will direct the Contractor to proceed with the said work as so modified. If an increase in the quantity of work so ordered should result in delay to the work, the Contractor will be given an equivalent extension of time.

All estimates and all measurements used in determining the quantities of unit price items of work done, the percentage of completion of lump sum items of work, and the quantity of materials furnished under the Contract at various times during the progress of the work must be the Engineer's estimates and measurements.

The planimeter must be considered an instrument of precision adapted to the measurements of all areas.

Insurance. The bidder's attention is drawn to Special Provisions, Location and Description of Work, and Special Provisions, Minimum Limits of Insurance.

Inspection of Site. The bidder must examine carefully the site of the work contemplated and the proposal, plans, specifications, and the Contract form therefor. It will be assumed that the bidder has investigated and is satisfied as to the conditions to be encountered, as to the character, quality, and quantities of work to be performed and materials to be furnished, and as to the requirements of these specifications, the special provisions, and the Contract.

Where investigation of subsurface conditions has been made by the City in respect to foundation or other design, bidders may inspect the records of the City as to such investigation, including examination of samples, if available. When the Plans include a log of test borings showing a record of the data obtained by the City's investigation of subsurface conditions, said log represents only the opinion of the City as to the character of material encountered by it in its test borings and is only included for the convenience of bidders.

Investigations of subsurface conditions are made for the purpose of design. The City assumes no responsibility whatever in respect to the sufficiency or accuracy of borings or of the log of test borings or other preliminary investigations, or of the interpretation thereof, and there is no guaranty, either expressed or implied, that the conditions indicated are representative of those existing throughout the work, or any part of it, or that unlooked for developments may not occur.

Making such information available to the bidders is not to be construed in any way as a waiver of the provisions of the first paragraph of this article and bidders must satisfy themselves through their own investigations as to conditions to be encountered.

No information derived from such inspection of the records of preliminary investigations made by the City or from the maps, plans, specifications, profiles or drawings will in any way relieve the Contractor from any risk from properly fulfilling all the terms of the Contract.

Records of such preliminary investigations as may have been made by the City may be inspected at the office of the Engineer.

Pre-construction Meeting. At the pre-construction meeting, the successful bidder must submit a CPM progress schedule which will show the time he/she proposes to occupy in prosecuting the various major divisions of work and his/her proposed sequence of operations. The CPM progress schedule must be subject to the approval of the City Engineer.

Adjustment of Schedule. If at any time the construction schedule is inadequate to secure completion of the work within the time specified, and the work is being prosecuted inadequately or improperly, the Engineer must have the right to require the Contractor to submit a revised progress schedule, providing for proper and timely completion of the work.

The Contractor must not be entitled to additional compensation on account of revisions required by the City.

BIDDER'S PROPOSAL

GOLF COURSE DRIVE PEDESTRIAN RAMP IMPROVEMENT PROJECTS
PROJECT NO. 2019-28

To: City Council, City of Rohnert Park

The undersigned hereby declares:

- (a) That the only persons or parties interested in this proposal as principals are the following:

(If the bidder is a corporation, give the name of the corporation and the name of its president, secretary, treasurer, and manager. If a co-partnership, give the name under which the co-partnership does business, and the names and addresses of all co-partners. If an individual, state the name under which the contract is to be drawn.)

- (b) That this proposal is made without collusion with any other person, firm, or corporation.
- (c) That he/she has carefully examined the locations of the proposed work, and has familiarized himself/herself with all of the physical and climatic conditions, and makes this bid solely upon his/her own knowledge.
- (d) That he/she has carefully examined the drawings and specifications and makes this proposal in accordance therewith.
- (e) That, if this bid is accepted, he/she agrees to enter into an agreement with City in the form included in the Contract Documents to complete all work as specified in the Contract for the contract price and within the contract time indicated in this bid and in accordance with the Contract Documents.
- (f) That this bid will remain open and not be withdrawn for the period specified in the Instructions to Bidders.
- (g) That he/she has read the insurance requirements in Section 2.03, Insurance in the Special Provisions section of this bid document;
- (h) That he/she has conferred with his/her insurance carriers or brokers to determine in advance of the bid submission the availability of insurance certificates and endorsements as prescribed and provided herein;
- (i) That if the bid is accepted, he/she will enter into a written contract and within fifteen (15) calendar days furnish the required proof of insurance including certificates and endorsements;
- (j) That failure to comply strictly with the insurance requirements may result in forfeiture of the bid security and withdrawal of the bid proposal.
- (k) That he/she is properly licensed in accordance with California Business and Professions Code section 7000 et seq. Bidder acknowledges that if the bidder is not properly licensed at the time the bid is awarded or as otherwise required by law, the bid will be considered non-responsive and will be rejected.
- (l) That he/she and any subcontractor relied on by him will keep an accurate payroll record, showing the name, address, social security number, work classification, straight time and overtime hours worked each day and week, and the actual per diem wages paid to each journeyman, apprentice, worker, or other employee employed by the contractor or subcontractor in connection with the public work, as more fully set forth in the Contract. All contractors and subcontractors must furnish

electronic certified payroll records directly to the Labor Commissioner (aka Division of Labor Standards Enforcement).

- (m) That in compliance with the Subletting and Subcontracting Fair Practices Act, California Public Contracts Code section 4100 et seq., he/she has listed on the attached "List of Subcontractors" each subcontractor who will perform work or labor or render service to the bidder in or about the construction of the work or will specifically fabricate and install a portion of the work in an amount in excess of one half of one percent (0.5%) of the total bid sum or in the case of bids or offers for the construction of streets or highways, including bridges, in excess of one-half of one percent (0.5%) of the total bid or \$10,000, whichever is greater, and that no subcontractors may be used other than those specified without written approval of the City Engineer.

Accompanying this proposal is a certified or cashier's check, or bidder's bond payable to the order of the City Clerk of the City of Rohnert Park, in the sum of _____ Dollars (\$_____). Said bidder's bond submitted is the City's bid bond form. Said bidder's bond has been duly executed by the undersigned bidder and by a financially sound surety company admitted in the State of California.

It is understood and agreed that should the bidder fail within fifteen (15) calendar days after the date of mailing written notice to the successful bidder that the contract has been awarded, to enter into the contract and furnish acceptable surety bonds and insurance on forms included herein, then the proceeds of said check, or bidder's bond, must become the property of the City. But if the contract is entered into and said bonds are furnished or if the bid is not accepted, then said check must be returned to the undersigned or the bidder will be released from the bidder's bond.

Address of Bidder

Telephone Number of Bidder

City, State, Zip

Signature of Bidder

SCHEDULE OF BID PRICES

GOLF COURSE DRIVE PEDESTRIAN RAMP IMPROVEMENT PROJECT

PROJECT NO. 2019-28

In accordance with the plans and specifications therefor approved by the City of Rohnert Park, the undersigned bidder is herewith submitting the following bid prices for the performance of the entire proposed work as described in these specifications and attached drawings.

ITEM NO.	ITEM DESCRIPTION	QUANTITY	UNIT	UNIT PRICE	TOTAL COST
100	MOBILIZATION	1	LS		
101	WATER POLLUTION CONTROL PLAN	1	LS		
102	CLEARING AND GRUBBING	1	LS		
103	REMOVE STRIPING	1	LS		
104	REMOVE ASPHALT CONCRETE	1940	SF		
105	REMOVE CURB AND GUTTER	100	LF		
106	REMOVE CONCRETE	590	SF		
107	HOT MIX ASPHALT	30	TON		
108	CONCRETE CURB RAMP	310	SF		
109	CONCRETE SIDEWALK	365	SF		
110	CONCRETE CURB AND GUTTER	130	LF		
111	CONCRETE VERTICAL CURB	55	LF		
112	6" COBBLE STONE EMBEDDED IN CONCRETE	110	SF		
113	TRUNCATED DOMES	30	SF		
114	THERMOPLASTIC STRIPING - CROSSWALK	1137	SF		
115	THERMOPLASTIC STRIPING - YIELD LINE	129	SF		
116	DOUBLE-SIDED RRFB ASSEMBLY	6	EA		
117	SIGN AND POST	1	EA		
118	SIGN POST	1	EA		
119	RELOCATE SIGN	1	EA		
120	REMOVE AND SALVAGE SIGN	2	EA		
121	PAVEMENT MARKING	312	SF		

Total Amount of Bid (written in words) is: _____ Dollars

and _____ Cents.

Any discrepancy between words and figures shall be resolved as provided in the Instructions to Bidders.

\$ _____
(Figures)

Address of Bidder

Signature of Bidder

City, State, Zip

Name of Bidder (Print)

Telephone Number of Bidder

FAX Number of Bidder

Contractor's License Number

License's Expiration Date

Contractor's DIR Number

Contractor's email address

ADDENDUM ACKNOWLEDGEMENT

ADDENDUM #1 Date _____ Signature acknowledging receipt: _____

ADDENDUM #2 Date _____ Signature acknowledging receipt: _____

ADDENDUM #3 Date _____ Signature acknowledging receipt: _____

CONTRACTOR'S LICENSE DECLARATION
(Business and Professions Code Section 7028.15)

The undersigned declares that he or she is _____ of _____ (party making foregoing bid) (hereinafter the "Bidder")

1. Bidder's Contractor's License Number is as follows: _____.
2. The expiration date of Bidder's Contractor's License is _____, 20__.
3. Bidder acknowledges that pursuant to Section 7028.15(a) of the Business and Professions Code it is a misdemeanor for any person to submit a bid to a public agency in order to engage in the business or act in the capacity of a contractor within this state without having a license therefor, except as provided therein.

The undersigned declares, under penalty of perjury, that the representations made by the undersigned in this bid proposal are true and correct.

Executed on _____, 20 __, at _____ (insert city and state where Declaration signed).

Signature

Typed Name

Title

Name of Bidder

LIST OF SUBCONTRACTORS

In accordance with the provisions of Sections 4102 to 4108, inclusive, of the Public Contract Code of the State of California, each bidder must list below the name and location of place of business, contractors license number and Department of Industrial Relations registration number of each subcontractor who will perform a portion of the contract work in an amount in excess of one-half of one percent of the total contract price. In each such instance, the nature and extent of the work to be sublet must be described.

Subcontractor name, and California Contractor's License Number and DIR Registration Number	Location of Place of Business	Description of Work to be Performed (also show bid Schedule Item No.)	Percentage of total contract work to be performed
Name:			
CLN:			
DIR:			
Name:			
CLN:			
DIR:			
Name:			
CLN:			
DIR:			
Name:			
CLN:			
DIR:			
Name:			
CLN:			
DIR:			
Name:			
CLN:			
DIR:			
Name:			
CLN:			
DIR:			
Name:			
CLN:			
DIR:			

[Add additional sheets if necessary]

****Note, the Subletting and Subcontracting Fair Practices Act also requires inclusion of any subcontractor who specially fabricates and installs a portion of the work according to detailed drawings.**

BID BOND

Bond No. _____

WHEREAS, _____ ("Principal") intends to submit a bid to the City of Rohnert Park ("City") for the above-referenced Project, and the terms of the bid require the Principal to submit bidder's security.

NOW, THEREFORE, Principal and _____, a corporation organized and existing under the laws of the State of _____ and duly authorized to transact business under the laws of the State of California, as Surety, are held and firmly bond unto City in the sum of _____ dollars (\$ _____) lawful money of the United States of America, such sum being not less than ten percent (10%) of the bid amount for the payment of which sum to be made, the Principal and Surety, bind ourselves, our heirs, executors, administrators, successors and assigns, jointly and severally, firmly by these presents.

THE CONDITION OF THIS OBLIGATION IS SUCH THAT, if the Principal submits a bid for the above-referenced Project, the terms and conditions of which are incorporated herein by reference, and if said bid is rejected by the City, or if said bid is accepted by the City and the Bidder properly executes and submits to the City the Agreement and all required documents (including the Performance bond, the Payment Bond, and the proof of insurance), then this obligation must be null and void; otherwise it must be and remain in full force and effect.

The Surety hereby agrees, for value received, that its obligations under this bond must in no way be impaired or modified by an agreement between the City and the Principal to extend the time within which the City may accept the Principal's bid, and the surety hereby waives notice of any such extension.

In the event suit is brought upon this bond, the surety must pay reasonable attorneys' fees and costs incurred by the prevailing parties in such suit, which fees and costs must be in addition to the face amount of the bond.

IN WITNESS WHEREOF, the undersigned represent and warrant that they have the right, power, legal capacity, and authority to enter into and execute this document on behalf of the Principal and the Surety, and have caused this document to be executed by setting hereto their names, titles and signatures.

Principal: _____
(Name of Firm)

Surety: _____
(Name of Firm)

By: _____

By: _____

Title: _____

Title: _____

Date: _____

Date: _____

Address for Notices to Surety:

Note: Notary acknowledgment for Surety and Surety's Power of Attorney must be attached.

NONCOLLUSION DECLARATION

TO BE EXECUTED BY BIDDER AND SUBMITTED WITH BID

The undersigned declares:

I am the _____ of _____, the party making the foregoing bid.

The bid is not made in the interest of, or on behalf of, any undisclosed person, partnership, company, association, organization, or corporation. The bid is genuine and not collusive or sham. The bidder has not directly or indirectly induced or solicited any other bidder to put in a false or sham bid. The bidder has not directly or indirectly colluded, conspired, connived, or agreed with any bidder or anyone else to put in a sham bid, or to refrain from bidding. The bidder has not in any manner, directly or indirectly, sought by agreement, communication, or conference with anyone to fix the bid price of the bidder or any other bidder, or to fix any overhead, profit, or cost element of the bid price, or of that of any other bidder. All statements contained in the bid are true. The bidder has not, directly or indirectly, submitted his or her bid price or any breakdown thereof, or the contents thereof, or divulged information or data relative thereto, to any corporation, partnership, company, association, organization, bid depository, or to any member or agent thereof, to effectuate a collusive or sham bid, and has not paid, and will not pay, any person or entity for such purpose.

Any person executing this declaration on behalf of a bidder that is a corporation, partnership, joint venture, limited liability company, limited liability partnership, or any other entity, hereby represents that he or she has full power to execute, and does execute, this declaration on behalf of the bidder.

I declare under penalty of perjury under the laws of the State of California that the foregoing is true and correct, and that this declaration is executed on _____ [date], at _____ [city], _____ [state].

Firm (print or type)

Signature

DECLARATION OF ELIGIBILITY TO CONTRACT

The undersigned, a duly authorized representative of the bidder, certifies and declares that:

1. The bidder is aware of California Labor Code sections 1771.1 and 1777.7, which prohibit a contractor or subcontractor who has been found by the Labor Commissioner or the Director of Industrial Relations to be in violation of certain provisions of the Labor Code from bidding on, being awarded, or performing work as a subcontractor on a public works project for specified periods of time.
2. The bidder is not prohibited from bidding on, being awarded, or performing work as a contractor or subcontractor on a public works project under Labor Code sections 1771.1 and 1777.7, or any other provision of law.
3. The bidder is aware of California Public Contract Code section 6109, which states:
 - "(a) A public entity, as defined in Section 1100 [of the Public Contract Code], may not permit a contractor or subcontractor who is ineligible to bid or work on, or be awarded, a public works project pursuant to Section 1771.1 or 1777.7 of the Labor Code to bid on, be awarded, or perform work as a subcontractor on, a public works project. Every public works project shall contain a provision prohibiting a contractor from performing work on a public works project with a subcontractor who is ineligible to perform work on the public works project pursuant to Section 1777.1 or 1777.7 of the Labor Code.
 - (b) Any contract on a public works project entered into between a contractor and a debarred subcontractor is void as a matter of law. A debarred subcontractor may not receive any public money for performing work as a subcontractor on a public works contract, and any public money that may have been paid to a debarred subcontractor by a contractor on the project will be returned to the awarding body. The contractor is responsible for the payment of wages to workers of a debarred subcontractor who has been allowed to work on the project."
4. The bidder has investigated the eligibility of each and every subcontractor that bidder intends to use on this public works project, and determined that none of them is ineligible to perform work as a subcontractor on a public works project by virtue of Public Contract Code section 6109, Labor Code sections 1771.1 and 1777.7, or any other provision of law.

I declare under penalty of perjury under the laws of the State of California that the foregoing is true and correct.

Executed this _____ day of _____, 20____, at _____, California.

Signature and Title of Authorized Official

C O N T R A C T

GOLF COURSE DRIVE PEDESTRIAN IMPROVEMENT PROJECT PROJECT NO. 2019-28

THIS AGREEMENT, made and entered into this _____ day of _____, 20____, by and between _____, hereinafter called "Contractor", and the City of Rohnert Park, hereinafter called "City".

WHEREAS, the City Council of said City has awarded a contract to Contractor for performing the work hereinafter mentioned in accordance with the sealed proposal of said Contractor.

NOW, THEREFORE, IT IS AGREED, as follows:

1. Scope of Work: The Contractor must perform all the work and furnish all the labor, materials, equipment and all utility and transportation services required to complete all of the work of construction and installation of the improvements more particularly described in the Resolution adopted by the City Council of said City on <<MONTH DAY, YEAR>>, the items and quantities of which are more particularly set forth in the Contractor's bid therefor on file in the office of the City Clerk, except work to be performed by subcontractors as set forth in the Contractor's bid and for which the Contractor retains responsibility.

2. Time of Performance and Liquidated Damages: The Contractor must begin work within fifteen (15) calendar days after official notice by the City Engineer to proceed with the work and must diligently prosecute the same to completion within 180 calendar days of that Notice. The Contractor acknowledges and agrees that time is of the essence with respect to Contractor's work and that Contractor shall diligently pursue performance of the work.

In the event the Contractor does not complete the work within the time limit so specified or within such further time as said City Council must have authorized, the Contractor must pay to the City liquidated damages in the amount of Two Thousand Eight Hundred Dollars (\$2,800) per day for each and every day's delay in finishing the work beyond the completion date so specified. Additional provisions with regard to said time of completion and liquidated damages are set forth in the specifications, which provisions are hereby referred to and incorporated herein by reference.

3. Payments: Payments will be made by City to the Contractor for said work performed at the times and in the manner provided in the specifications and at the unit prices stated in Contractor's bid.

The award of the contract is for a total amount of <<AMOUNT>>.

4. Component Parts and Interpretation: This contract must consist of the following documents, each of which is on file in the office of the City Clerk and all of which are incorporated herein and made a part hereof by reference thereto:

- a) This Agreement
- b) Notice Inviting Sealed Proposals
- c) Instruction and Information to Bidders
- d) Accepted Proposal, with all attachments and certifications
- e) Performance Bond
- f) Payment Bond
- g) Special Provisions
- h) Standard Specifications

- i) Technical specifications
- j) Design Standards
- k) Plans, Profiles and Detailed Drawings

In the event of conflict between these documents, the following order of precedence will govern: this contract; change orders; supplemental agreements and approved revisions to plans and specifications; special conditions; standard specifications; detail plans; general plans; standard plans; reference specifications. In the absence of a controlling or contrary provision in the foregoing, the *Standard Specifications* (2022 edition) of the California Department of Transportation shall apply to this project.

5. Independent Contractor. Contractor is and will at all times remain as to City a wholly independent contractor. Neither City nor any of its officers, employees, or agents will have control over the conduct of Contractor or any of Contractor's officers, employees, agents or subcontractors, except as expressly set forth in the Contract Documents. Contractor may not at any time or in any manner represent that it or any of its officers, employees, agents, or subcontractors are in any manner officers, employees, agents or subcontractors of City.

6. Prevailing Wages: Copies of the determination of the Director of the Department of Industrial Relations of the prevailing rate of per diem wages for each craft, classification or type of worker needed to execute this Contract will be on file in, and available at, the office of the Director at 601 Carmen Drive, Camarillo, California 93010.

Contractor must post at the work site, or if there is no regular work site then at its principal office, for the duration of the Contract, a copy of the determination by the Director of the Department of Industrial Relations of the specified prevailing rate of per diem wages. (Labor Code § 1773.2.)

Contractor, and any subcontractor engaged by Contractor, may pay not less than the specified prevailing rate of per diem wages to all workers employed in the execution of the contract. (Labor Code § 1774.) Contractor is responsible for compliance with Labor Code section 1776 relative to the retention and inspection of payroll records.

Contractor must comply with all provisions of Labor Code section 1775. Under Section 1775, Contractor may forfeit as a penalty to City up to \$200.00 for each worker employed in the execution of the Contract by Contractor or any subcontractor for each calendar day, or portion thereof, in which the worker is paid less than the prevailing rates. Contractor may also be liable to pay the difference between the prevailing wage rates and the amount paid to each worker for each calendar day, or portion thereof, for which each worker was paid less than the prevailing wage rate.

Nothing in this Contract prevents Contractor or any subcontractor from employing properly registered apprentices in the execution of the Contract. Contractor is responsible for compliance with Labor Code section 1777.5 for all apprenticeable occupations. This statute requires that contractors and subcontractors must submit contract award information to the applicable joint apprenticeship committee, must employ apprentices in apprenticeable occupations in a ratio of not less than one hour of apprentice's work for every five hours of labor performed by a journeyman (unless an exception is granted under § 1777.5), must contribute to the fund or funds in each craft or trade or a like amount to the California Apprenticeship Council, and that contractors and subcontractors must not discriminate among otherwise qualified employees as apprentices solely on the ground of sex, race, religion, creed, national origin, ancestry or color. Only apprentices defined in Labor Code section 3077, who are in training under apprenticeship standards and who have written apprentice contracts, may be employed on public works in apprenticeable occupations.

With each application for payment, Contractor shall also deliver certified payrolls to Owner as set forth above in these General Conditions, and concurrently therewith (but in no event less frequently than monthly) directly to the Labor Commissioner in the format prescribed by the Labor Commissioner.

If federal funds are used to pay for the Work, Contractor and any subcontractor agree to comply, as applicable, with the labor and reporting requirements of the Davis-Bacon Act (40 USC § 276a-7), the Copeland Act (40 USC § 276c and 18 USC § 874), and the Contract Work Hours and Safety Standards Act (40 USC § 327 and following).

7. Hours of Labor: Contractor acknowledges that under California Labor Code sections 1810 and following, eight hours of labor constitutes a legal day's work. Contractor will forfeit as a penalty to City the sum of \$25.00 for each worker employed in the execution of this Contract by Contractor or any subcontractor for each calendar day during which such worker is required or permitted to work more than eight hours in any one calendar day and 40 hours in any one calendar week in violation of the provisions of Labor Code section 1810.

8. Apprentices: Attention is directed to the provisions in Sections 1777.5 (Chapter 1411, Statutes of 1968) and 1777.6 of the Labor Code concerning the employment of apprentices by the Contractor or any Subcontractor under him.

Section 1777.5, as amended, requires the Contractor or Subcontractor employing tradesmen in any apprenticeable occupation to apply to the joint apprenticeship committee nearest the site of the public works project and which administers the apprenticeship program in that trade for a certificate of approval. The certificate will also fix the ratio of apprentices to journeymen that will be used in the performance of the Contract. The ratio of apprentices to journeymen in such cases must not be less than one to five except:

- A. When unemployment in the area of coverage by the joint apprenticeship committee has exceeded an average of 15 percent in the 90 days prior to the request for certificate, or
- B. When the number of apprentices in training in that area exceeds a ratio of one to five, or
- C. When the trade can show that it is replacing at least 1/30 of its membership through apprenticeship training on an annual basis statewide or locally, or
- D. When the assignment of an apprentice to any work performed under a public works Contract would create a condition which would jeopardize his life or the life, safety, or property of fellow employees or the public at large, or if the specified task to which the apprentice is to be assigned is of such a nature that training cannot be provided by a journeyman, or
- E. When the Contractor provides evidence that he employs registered apprentices on all of his Contracts on an annual average of not less than one apprentice to eight journeymen.

The Contractor is required to make contributions to funds established for the administration of apprenticeship program if he employs registered apprentices or journeymen in any apprenticeable trade on such Contracts and if other Contractors on the public works site are making such contributions.

The Contractor and any Subcontractor under him must comply with the requirements of Section 1777.5 and 1777.6 in the employment of apprentices.

Information relative to apprenticeship standards, wage schedules, and other requirements may be obtained from the Director of Industrial Relations, ex officio the Administrator of Apprenticeship, San Francisco, California, or from the Division of Apprenticeship Standards and its branch offices. .

9. Labor Discrimination: Attention is directed to Section 1735 of the Labor Code, which reads as follows:

"A contractor must not discriminate in the employment of persons upon public

works on any basis listed in subdivision (a) of Section 12940 of the Government Code, as those bases are defined in Sections 12926 and 12926.1 of the Government Code, except as otherwise provided in Section 12940 of the Government Code. Every contractor for public works who violates this section is subject to all the penalties imposed for a violation of this chapter. "

10. Workmen's Compensation Insurance: In accordance with the provisions of Article 5, Chapter 1, Part 7, Division 2 (commencing with Section 1860) and Chapter 4, Part 1, Division 4 (commencing with Section 3700) of the Labor Code of the State of California, the Contractor is required to secure the payment of compensation to his employees and must for that purpose obtain and keep in effect adequate Workmen's Compensation Insurance.

The undersigned Contractor is aware of the provisions of Section 3700 of the Labor Code which requires every employer to be insured against liability for workmen's compensation or to undertake self-insurance in accordance with the provisions of that Code, and will comply with such provisions before commencing the performance of the work of this contract.

11. Indemnity and Insurance: To the fullest extent permitted by law (including without limitation California Civil Code Section 2782), Contractor must indemnify, hold harmless, release and defend City, its officers, elected officials, employees, agents, volunteers, and consultants from and against any and all actions, claims, demands, damages, disability, losses, expenses including, but not limited to, attorney's fees and other defense costs and liabilities of any nature that may be asserted by any person or entity including Contractor, in whole or in part, arising out of Contractor's activities hereunder, including the activities of other persons employed or utilized by Contractor including subcontractors hired by the Contractor in the performance of this Agreement excepting liabilities due to the sole negligence, intentional misconduct or active negligence of the City. This indemnification obligation is not limited in any way by any limitation on the amount or type of damages or compensation payable by or for Contractor under Worker's Compensation, disability or other employee benefit acts or the terms, applicability or limitations of any insurance held or provided by Contractor and must continue to bind the parties after termination/completion of this Agreement.

Contractor shall procure and maintain throughout the time for performance of the work under this Contract the insurance required by the Special Provisions. The requirement that Contractor procure and maintain insurance shall in no way be construed to limit the Contractor's duty to indemnify City as provided in the paragraph above.

Failure of City to monitor compliance with these requirements imposes no additional obligations on City and will in no way act as a waiver of any rights hereunder.

12. City Right of Termination and Right to Complete the Work. The City may terminate the Contract when conditions encountered during the work make it impossible or impracticable to proceed, or when the City is prevented from proceeding with the Contract by act of God, by law, or by official action of a public authority. In addition, the occurrence of any of the following is a default by Contractor under this Contract:

- A. Contractor refuses or fails to prosecute the Work or any part thereof with such diligence as will insure its completion within the time specified or any permitted extension.
- B. Contractor fails to complete the Work on time.
- C. Contractor is adjudged bankrupt, or makes a general assignment for the benefit of creditors, or a receiver is appointed on account of Contractor's insolvency.
- D. Contractor fails to supply enough properly skilled workers or proper materials to complete the Work in the time specified.
- E. Contractor fails to make prompt payment to any subcontractor or for material or

labor.

- F. Contractor fails to abide by any applicable laws, ordinances or instructions of City in performing the Work.
- G. Contractor breaches or fails to perform any obligation or duty under the Contract.

Upon the occurrence of a default by Contractor, the Director will serve a written notice of default on Contractor specifying the nature of the default and the steps needed to correct the default. Unless Contractor cures the default within 10 days after the service of such notice, or satisfactory arrangements acceptable to City for the correction or elimination of such default are made, as determined by City, City may thereafter terminate this Contract by serving written notice on Contractor. In such case, Contractor will not be entitled to receive any further payment, except for Work actually completed prior to such termination in accordance with the provisions of the Contract Documents.

In event of any such termination, City will also immediately serve written notice of the termination upon Contractor's surety. The surety will have the right to take over and perform pursuant to this Contract; provided, however, that if the surety does not give City written notice of its intention to take over and perform this Contract within five days after service of the notice of termination or does not commence performance within 10 days from the date of such notice, City may take over the Work and prosecute the same to completion by contract or by any other method it may deem advisable for the account and at the expense of Contractor. Contractor and the surety will be liable to City for any and all excess costs or other damages incurred by City in completing the Work.

If City takes over the Work as provided in this Section, City may, without liability for so doing, take possession of, and utilize in completing the Work, such materials, appliances, plant, and other property belonging to Contractor as may be on the site of the Work and necessary for the completion of the Work.

13. Substitution of Securities for Withheld Amounts: Pursuant to California Public Contracts Code Section 22300, securities may be substituted for any moneys withheld by a public agency to ensure performance under a contract. At the request and sole expense of the Contractor, securities equivalent to the amount withheld must be deposited with the public agency, or with a state or federally chartered bank as the escrow agent, who must pay such moneys to the Contractor upon satisfactory completion of the contract.

Securities eligible for substitution under this section must include those listed in the California Public Contracts Code Section 22300 or bank or savings and loan certificates of deposit. The Contractor must be the beneficial owner of any securities substituted for moneys withheld and must receive any interest thereon.

Alternatively, the Contractor may request and the City shall make payment of retentions earned directly to the escrow agent at the expense of the Contractor. At the expense of the Contractor, the Contractor may direct the investment of the payments into securities and the Contractor shall receive the interest earned on the investments upon the same terms provided for in Section 22300 for securities deposited by the Contractor. Upon satisfactory completion of the Contract, the Contractor shall receive from the escrow agent all securities, interest, and payments received by the escrow agent from the City, pursuant to the terms of this section.

Any escrow agreement entered into pursuant to this section must contain as a minimum the following provisions:

- a. The amount of securities to be deposited;
- b. The terms and conditions of conversion to cash in case of the default of the Contractor; and
- c. The termination of the escrow upon completion of the contract.

14. General Provisions

A. Authority to Execute. Each Party represents and warrants that all necessary action has been taken by such Party to authorize the undersigned to execute this Contract and to bind it to the performance of its obligations.

B. Assignment. Contractor may not assign this Contract without the prior written consent of City, which consent may be withheld in City's sole discretion since the experience and qualifications of Contractor were material considerations for this Contract.

C. Binding Effect. This Agreement is binding upon the heirs, executors, administrators, successors and permitted assigns of the Parties.

D. Integrated Contract. This Contract, including the Contract Documents, is the entire, complete, final and exclusive expression of the Parties with respect to the Work to be performed under this Contract and supersedes all other agreements or understandings, whether oral or written, between Contractor and City prior to the execution of this Contract.

E. Modification of Contract. No amendment to or modification of this Contract will be valid unless made in writing and approved by Contractor and by the City Council, City Manager or Assistant City Manager, as applicable. The Parties agree that this requirement for written modifications cannot be waived and that any attempted waiver will be void.

F. Counterparts, Facsimile or other Electronic Signatures. This Contract may be executed in several counterparts, each of which will be deemed an original, and all of which, when taken together, constitute one and the same instrument. Amendments to this Contract will be considered executed when the signature of a party is delivered by facsimile or other electronic transmission. Such facsimile or other electronic signature will have the same effect as an original signature.

G. Waiver. Waiver by any Party of any term, condition, or covenant of this Contract will not constitute a waiver of any other term, condition, or covenant. Waiver by any Party of any breach of the provisions of this Contract will not constitute a waiver of any other provision, or a waiver of any subsequent breach or violation of any provision of this Contract. Acceptance by City of any Work performed by Contractor will not constitute a waiver of any of the provisions of this Contract.

H. Interpretation. This Contract will be interpreted, construed and governed according to the laws of the State of California. Each party has had the opportunity to review this Contract with legal counsel. The Contract will be construed simply, as a whole, and in accordance with its fair meaning. It will not be interpreted strictly for or against either party.

I. Severability. If any term, condition or covenant of this Contract is declared or determined by any court of competent jurisdiction to be invalid, void or unenforceable, the remaining provisions of this Contract will not be affected and the Contract will be read and construed without the invalid, void or unenforceable provision.

J. Venue. In the event of litigation between the parties, venue in state trial courts will be in the County of Sonoma. In the event of litigation in a U.S. District Court, venue will be in the Northern District of California.

IN WITNESS WHEREOF, the City of Rohnert Park has caused these presents to be executed by its officers, thereunto duly authorized, and Contractor has subscribed same, all on the day and year first above written.

INSURANCE

Bidder's attention is directed to the following insurance forms and to Section 2.03 of the Special Provisions, located on Pages 2-1 through 2-6 in the Special Provisions section. It is highly recommended that bidders confer with their respective insurance carriers or brokers to determine in advance of bid submission the availability of insurance certificates and endorsements as prescribed and provided herein. Failure to comply strictly with the insurance requirements may result in forfeiture of the bid security and withdrawal of the bid proposal.

CERTIFICATE OF INSURANCE

CITY OF ROHNERT PARK (the "City")

ISSUE DATE MM/DD/YY

PRODUCER	THIS CERTIFICATE OF INSURANCE IS NOT AN INSURANCE POLICY AND DOES NOT AMEND, EXTEND OR ALTER THE COVERAGE AFFORDED BY THE POLICIES BELOW.																		
INSURED	<table style="width: 100%; border-collapse: collapse;"> <thead> <tr> <th style="width: 60%;"></th> <th style="text-align: center; width: 20%;">COMPANIES</th> <th style="text-align: center; width: 20%;">BEST'S RATING</th> </tr> </thead> <tbody> <tr> <td>COMPANY LETTER A</td> <td>_____</td> <td>_____</td> </tr> <tr> <td>COMPANY LETTER B</td> <td>_____</td> <td>_____</td> </tr> <tr> <td>COMPANY LETTER C</td> <td>_____</td> <td>_____</td> </tr> <tr> <td>COMPANY LETTER D</td> <td>_____</td> <td>_____</td> </tr> <tr> <td>COMPANY LETTER E</td> <td>_____</td> <td>_____</td> </tr> </tbody> </table>		COMPANIES	BEST'S RATING	COMPANY LETTER A	_____	_____	COMPANY LETTER B	_____	_____	COMPANY LETTER C	_____	_____	COMPANY LETTER D	_____	_____	COMPANY LETTER E	_____	_____
	COMPANIES	BEST'S RATING																	
COMPANY LETTER A	_____	_____																	
COMPANY LETTER B	_____	_____																	
COMPANY LETTER C	_____	_____																	
COMPANY LETTER D	_____	_____																	
COMPANY LETTER E	_____	_____																	

THIS IS TO CERTIFY THAT THE POLICIES OF INSURANCE LISTED BELOW HAVE BEEN ISSUED TO THE INSURED NAMED ABOVE FOR THE POLICY PERIOD INDICATED. NOTWITHSTANDING ANY REQUIREMENT, TERM OR CONDITION OF ANY CONTRACT OR OTHER DOCUMENT WITH RESPECT TO WHICH THIS CERTIFICATE MAY BE ISSUED OR MAY PERTAIN, THE INSURANCE AFFORDED BY THE POLICIES DESCRIBED HEREIN IS SUBJECT TO ALL TERMS, EXCLUSIONS AND CONDITIONS OF SUCH POLICIES. LIMITS SHOWN MAY HAVE BEEN REDUCED BY PAID CLAIMS.

CO LTR	TYPE OF INSURANCE	POLICY NUMBER	POLICY EFFECTIVE DATE (MM/DD/YY)	POLICY EXPIRATION DATE (MM/DD/YY)	ALL LIMITS IN THOUSANDS	
	GENERAL LIABILITY <input type="checkbox"/> COMMERCIAL GENERAL LIABILITY <input type="checkbox"/> CLAIMS MADE <input type="checkbox"/> OCCUR. <input type="checkbox"/> OWNER'S & CONTRACTOR'S PROT. <input type="checkbox"/> OTHER _____				GENERAL AGGREGATE	\$
					PRODUCTS-COMP/OPS AGGREGATE	\$
					PERSONAL & ADVERTISING INJURY	\$
					EACH OCCURRENCE	\$
					FIRE DAMAGE (Any one fire)	\$
					MEDICAL EXPENSE (Any one person)	\$
	AUTOMOBILE LIABILITY <input type="checkbox"/> ANY AUTO <input type="checkbox"/> ALL OWNED AUTOS <input type="checkbox"/> SCHEDULED AUTOS <input type="checkbox"/> HIRED AUTOS <input type="checkbox"/> NON-OWNED AUTOS <input type="checkbox"/> GARAGE LIABILITY				COMBINED SINGLE LIMIT	\$
					BODILY INJURY (Per person)	\$
					BODILY INJURY (Per accident)	\$
					PROPERTY DAMAGE	\$
	EXCESS LIABILITY <input type="checkbox"/> UMBRELLA <input type="checkbox"/> OTHER THAN UMBRELLA FORM				EACH OCCURRENCE	\$
					AGGREGATE	\$
	<input type="checkbox"/> WORKER'S COMPENSATION AND EMPLOYERS' LIABILITY				STATUTORY	
					EACH ACCIDENT	\$
					DISEASE-POLICY LIMIT	\$
					DISEASE-EACH EMPLOYEE	\$
	PROPERTY INSURANCE <input type="checkbox"/> COURSE OF CONSTRUCTION				AMOUNT OF INSURANCE	\$

DESCRIPTION OF OPERATIONS/LOCATIONS/VEHICLES/RESTRICTIONS/SPECIAL ITEMS

- THE FOLLOWING PROVISIONS APPLY:**
1. None of the above-described policies will be canceled until after 30 days' written notice has been given to the City at the address indicated below.
 2. The City of Rohnert Park, its officers, elected officials, employees, agents and volunteers are added as insureds on all liability insurance policies listed above.
 3. It is agreed that any insurance or self-insurance maintained by the City will apply in excess of and not contribute with, the insurance described above.
 4. The City is named a loss payee on the property insurance policies described above, if any.
 5. All rights of subrogation under the property insurance policy listed above have been waived against the City.
 6. The workers' compensation insurer named above, if any, agrees to waive all rights to subrogation against the City for injuries to employees of the insured resulting from work for the City or use of the City's premises or facilities.
 7. Attached hereto are copies of the applicable policy pages or endorsements regarding notice of cancellation, additional insured and waiver of subrogation matters.

CERTIFICATE HOLDER/ADDITIONAL INSURED CITY OF ROHNERT PARK 130 AVRAM AVENUE ROHNERT PARK, CA 94928	AUTHORIZED REPRESENTATIVE SIGNATURE _____ TITLE _____ PHONE NO. _____
---	---

THIS ENDORSEMENT CHANGES THE POLICY, PLEASE READ IT CAREFULLY

ADDITIONAL INSURED – OWNERS, LESSEES OR CONTRACTORS

This endorsement modifies insurance provided under the following:

COMMERCIAL GENERAL LIABILITY COVERAGE PART.

SCHEDULE

Name of Organization:

The City of Rohnert Park, its officers, elected officials, employees, agents and volunteers are named as additional insured.

(If no entry appears above, the information required to complete this endorsement will be shown in the Declarations as applicable to this endorsement).

WHO IS INSURED (Section II) is amended to include as an insured the person or organization shown in the Schedule but only with respect to liability arising out of "your work" performed for that insured.

Modifications to ISO for CG 20 10 11 85

1. The insured scheduled above includes the insured's elected or appointed officers, officials, employees, agents and volunteers.
2. This insurance must be primary as respects the insured shown in the schedule above, or if excess, must stand in an unbroken chain of coverage excess of the Named Insured's scheduled underlying primary coverage. In either event, any other insurance maintained by the Insured scheduled above must be in excess of this insurance and must not be called upon to contribute with it.
3. The insurance afforded by this policy must not be canceled except after thirty (30) days prior written notice by certified mail, return receipt requested, has been given to the Entity.
4. Coverage must not extend to any indemnity coverage for the active negligence of the additional insured in any case where an agreement to indemnify the additional insurance would be invalid under Subdivision (b) of Section 2782 of the Civil Code.

Signature-Authorized Representative

Address

CG 20 10 11 85 Insurance Services Office, Inc. Form (Modified)

PART 2 – SPECIAL PROVISIONS

SPECIAL PROVISIONS

2.01 PROJECT OWNER

The Project Owner is the City of Rohnert Park, California. Wherever in these or the Standard Specifications the word "Owner" appears, it must be interpreted to mean the City of Rohnert Park.

2.02 LOCATION AND DESCRIPTION OF WORK

Location of work is within the City of Rohnert Park at the intersections of Golf Course Drive/Hacienda Way and Golf Course Drive/Halcyon Place.

The work generally consists of, but not limited to, removing asphalt concrete and striping, modifying existing curbs and sidewalks to furnish and install curb ramps, modifying median island for pedestrian accessibility, furnishing and installing new striping and signage, and installing rectangular rapid flashing beacon assemblies (RRFBs), and appurtenances as shown on the plans and specified in these Special Provisions.

2.03 INSURANCE

INSURANCE REQUIREMENTS FOR CONTRACTORS

The following parties or entities must be listed as additional insured by endorsement:

- A. The City of Rohnert Park, its officers, elected officials, employees, agents and volunteers

BIDDER'S ATTENTION IS DIRECTED TO THE INSURANCE REQUIREMENTS BELOW. IT IS HIGHLY RECOMMENDED THAT BIDDERS CONFER WITH THEIR RESPECTIVE INSURANCE CARRIERS OR BROKERS TO DETERMINE IN ADVANCE OF BID SUBMISSION THE AVAILABILITY OF INSURANCE CERTIFICATES AND ENDORSEMENTS AS PRESCRIBED AND PROVIDED HEREIN. IF AN APPARENT LOW BIDDER FAILS TO COMPLY STRICTLY WITH THE INSURANCE REQUIREMENTS, THAT BIDDER MAY BE DISQUALIFIED FROM AWARD OF THE CONTRACT.

Contractors must procure and maintain for the duration of the contract insurance against claims for injuries to persons or damages to property which may arise from or in connection with the performance of the work hereunder by the Contractor, the contractor's agents, representatives, employees or subcontractors. The coverage of the above-named parties as additional insureds shall be "primary and non-contributory" and must state that it will not seek contribution from the City's insurance or self-insurance. The cost of Contractor's insurance must be included in the Contractor's bid. The Notice to Proceed with the Work will not be issued, and the Contractor must not commence work, until such insurance has been approved by the City. Such insurance must remain in full force and effect at all times during the prosecution of the Work and until the final completion and acceptance thereof. In addition, the Commercial General Liability Insurance must be maintained for a minimum of three (3) years after final completion and acceptance of the Work. It must be the Contractor's responsibility to ensure that proof of insurance is sent to the City during this time. The Notice to Proceed does not relieve the Contractor of the duty to obtain such insurance as required herein.

A. Minimum Scope of Insurance

Coverage must be at least as broad as:

1. Insurance Services Office Commercial General Liability coverage (Occurrence Form CG 0001).
2. Insurance Services Office form number CA 0001 (Ed. 1/87) covering Automobile Liability, Code 1 "any auto" or the exact equivalent. If Contractor owns no vehicles, this requirement may be satisfied by a non-owned auto endorsement to the general liability policy described above. If Contractor or Contractor's employee(s) will use personal autos in any way on this project, Contractor must provide evidence of personal auto liability coverage for each such person.
3. Workers' Compensation and Employers Liability: Workers' Compensation on a state-approved policy form providing statutory benefits as required by law with employer's liability insurance, with minimum limits of One Million Dollars (\$1,000,000) per occurrence.
4. Course of Construction insurance coverage must provide "all risk" coverage for the completed value of the project. Policies must contain the following provisions:
 - a. The City must be named as loss payee, and
 - b. The insurer must waive all rights of subrogation against the City.

Coverage must not extend to any indemnity coverage for the active negligence of the additional insured in any case where an agreement to indemnify the additional insured would be invalid under Subsection (b) of Section 2782 of the Civil Code.

B. Minimum Limits of Insurance

Contractor must maintain limits no less than:

1. Commercial General Liability: \$2,000,000 per occurrence for bodily injury, personal injury and property damage and \$2,000,000 general aggregate. It is permissible to use excess/umbrella coverage to meet limit requirements provided the umbrella policies are appropriately endorsed and meet all other requirements. Additionally, a letter clearly identifying the primary policy or policies to which the excess umbrella coverage applies must be submitted attesting to the following: *"Umbrella or excess liability policies must provide coverage at least as broad as specified for underlying coverages and covering those insured in the underlying policies. Coverage must be "pay on behalf", with defense costs payable in addition to policy limits. There must be no cross liability exclusion of claims or suits by one insured against another, and such coverage must also apply on a primary and non-contributory basis for the benefit of the City before the City's own insurance or self-insurance shall be called upon to protect it as a named insured."*
2. Automobile Liability: \$2,000,000 combined single limit per accident for bodily injury and property damage.
3. Workers' Compensation and Employers Liability: Workers' Compensation providing statutory benefits as required by the Labor Code of the State of California with employers liability insurance, with minimum limits of \$1,000,000 per accident or disease.
4. Course of Construction insurance coverage must provide "all risk" coverage for the completed value of the project. Policies must contain the following provisions:

- a. The City must be named as loss payee, and
- b. The insurer must waive all rights of subrogation against the City.

Contractor agrees that any available insurance proceeds broader than or in excess of these specified minimum coverage requirements or the limits in subsection (A) shall be available to the additional insureds named above. Furthermore, the requirements for coverage and limits shall be (1) the minimum coverage and limits specified herein; or (2) such broader coverage and maximum limits of coverage of any insurance policy or proceeds available to the named insured for the work performed; whichever is greater.

C. Deductibles and Self-Insured Retentions

Any deductibles or self-insured retentions must be declared to and approved by the City. At the option of the City, either: the insurer must reduce or eliminate such deductibles or self-insured retentions as respects the City, its officers, elected officials, employees, agents, and volunteers; or the Contractor must procure a bond guaranteeing payment of losses and related investigations, claim administration and defense expenses.

D. Other Insurance Provisions

The policies are to contain, or be endorsed to contain, the following provisions:

1. General Liability and Automobile Liability Coverages
 - a. The City, its officers, elected officials, employees, agents and volunteers are to be covered as insureds as respects: liability arising out of activities performed by or on behalf of the Contractor, including the insured's general supervision of the Contractor; products and completed operations of the Contractor, premises owned, occupied or used by the Contractor, or automobiles owned, leased, hired or borrowed by the Contractor. The coverage must contain no special limitations on the scope of protection afforded to the City, its officers, elected officials, employees, agents or volunteers.
 - b. The Contractor's insurance coverage must be primary insurance as respects the City, its officers, elected officials, employees, agents and volunteers. Any insurance or self-insurance maintained by the City, its officers, elected officials, employees, agents or volunteers must be in excess of Contractor's insurance and must not contribute with it.
 - c. Any failure to comply with reporting provisions of the policies must not affect coverage provided to the City, its officers, elected officials, employees, agents or volunteers.
 - d. The Contractor's insurance must apply separately to each insured against whom claim is made or suit is brought, except with respect to the limits of the insurer's liability.
2. Workers' Compensation and Employers Liability Coverage

The insurer must agree to waive all rights of subrogation against the City, its officers, elected officials, employees, agents and volunteers for losses arising from work performed by Contractor for the City.

3. All Coverages
 - a. Each insurance policy required by this clause must be endorsed to state that coverage must not be suspended, voided, cancelled by either party, reduced in coverage or in limits except after thirty (30) days' prior written notice by certified mail, return receipt requested, has been given to the City.
 - b. **Coverage must not extend to any indemnity coverage for the active negligence of the additional insured in any case where an agreement to indemnify the additional insured would be invalid under Subsection (b) of Section 2782 of the Civil Code.**
4. Course of Construction policies must contain the following provisions:
 - a. The City must be named as loss payee.
 - b. The insurer must waive all rights of subrogation against the City.

E. Acceptability of Insurers

Insurance is to be placed with insurers with a Best's rating of no less than A:VII or as approved by the City.

F. Verification of Coverage

Contractor must furnish the City with certificates of insurance and with original endorsements affecting coverage required by this clause. The certificates and endorsements for each insurance policy are to be signed by a person authorized by that insurer to bind coverage on its behalf. The certificates and endorsements are to be on forms provided by the City. Where by statute, the City's workers' compensation-related forms cannot be used, equivalent forms approved by the Insurance Commissioner are to be substituted. All certificates and endorsements are to be received and approved by the City before work commences. The City reserves the right to require complete, certified copies of all required insurance policies, at any time.

G. Subcontractors

Contractor must include all subcontractors as insureds under its policies or must furnish separate certificates and endorsements for each subcontractor. All coverages for subcontractors must be subject to all of the requirements stated herein.

2.04 BONDS

In accordance with Section 3.4 of the Standard Specifications, the Contractor must provide the following bonds:

Payment Bond equal to 100% of the Contract Bid Price, and Performance Bond equal to 100% of the Contract Bid Price on City's forms. Both bonds must, by its term, remain in full force and effect for a period of one (1) year after the completion and acceptance of said work to guarantee the replacing or making acceptable of any defective materials or faulty workmanship.

The Contractor may elect to post a maintenance bond equal to 100% of the contract bid price, which will run for one year after completion and acceptance of said work to guarantee replacing or making acceptable any defective materials or faulty workmanship prior to the acceptance of said work.

2.05 LIQUIDATED DAMAGES

In accordance with Section 8.6 of the Standard specifications, Liquidated Damages shall be agreed to amount to \$2,800.00 per calendar day.

2.06 WITHDRAWALS OF PROPOSALS

The City reserves the right to reject any and all bids and to waive any informality or irregularity in the bids received.

No bidder may withdraw his/her bid for a period of ninety (90) days from the opening thereof.

2.07 DRAWINGS AND SPECIFICATIONS

The drawings showing location and character of work are entitled Pedestrian Ramp Improvements, numbered 1 through 11 inclusive, and are included as a part of these specifications. The City of Rohnert Park 2010 Manual of Standards, Details and Specifications are the adopted Standard Plans for the City of Rohnert Park and are included as a part of these specifications.

Also included by reference as part of these specifications are the Standard Specifications of the CITY OF ROHNERT PARK, Sections 1-10 inclusive, hereinafter referred to as GENERAL PROVISIONS.

In addition, the technical provisions of the Standard Plans and Standard Specifications, State of California, Department of Transportation, Business and Transportation Agency, most current edition, and to revisions thereof are included by reference as a part of these specifications insofar as they refer to materials and methods of work where applicable. Wherever in the SPECIAL PROVISIONS reference is made to Caltrans STANDARD SPECIFICATIONS or Caltrans STANDARD PLANS, it is these specifications or plans referred to.

2.08 COOPERATION AND COLLATERAL WORKS

The Contractor must conform to the provisions of Section 7.26, "Cooperation and Collateral Works," of the STANDARD SPECIFICATIONS.

The Contractor must ascertain the nature and extent of any simultaneous collateral work and must coordinate his operations and cooperate to minimize interference.

2.09 PROTECTION AND RESTORATION OF EXISTING IMPROVEMENTS

The Contractor must conform to the provisions of Section 7.15, "Preservation of Property," of the STANDARD SPECIFICATIONS.

Without additional compensation, the Contractor may remove and replace, in a condition as good as or better than original, such small miscellaneous structures as fences and sign posts, that interfere with the Contractor's operations.

All costs to the Contractor for protecting, removing, modifying, relocating and restoring existing improvements must be considered as included in the contract prices paid for the various items of work, and no additional allowance will be made therefor.

2.10 PERMITS AND LICENSES

The Contractor will not be required to obtain a City permit for this work.

The Contractor must have a valid California contractor's license, a Class A license. The Contractor and all subcontractors will be required to obtain a City Business license.

2.11 APPROVED DEBRIS HAULERS

There are three approved debris haulers within the City and contact information is listed below. The Contractor shall contract with one of the three debris haulers for service on the project. Payment for debris hauling shall be included within the Contractor's bid and no additional payment will be made for using one of the three approved debris haulers.

Industrial Carting (Global Materials Recovery Services C&D Recycling Facility) (707) 585-0511	Recology Sonoma Marin 800-243-0291 https://www.recology.com/recology-sonoma-marin/	Pacific Sanitation 707-838-2597 http://www.pacificsanitation.com/
--	--	---

When the Contractor utilizes a staging area or storage yard that is fenced and screened, final cleanup of the staging area and storage yard will be completed before the fence and screen are removed, except for spot cleanup or trimming that may be required in areas directly under or adjacent to the fence and screen.

Unless expressly waived by the City Engineer, when the contractor utilizes an area for storage of material or staging its activities, the area will be fenced and locked and all fencing will be installed with protective screening (i.e., green screen) to minimize the visual impact of the storage and staging area.

2.12 FIELD REVIEW PRIOR TO BIDDING

The bidder must examine carefully the site of the work contemplated and the proposal, plans, specifications, and the contract forms therefor. It will be assumed that the bidder has investigated and is satisfied as to the conditions to be encountered, as to the character, quality and quantities of work to be performed and materials to be furnished, and as to the requirements of these specifications, the Special Provisions, and the contract.

2.13 TESTING

The City of Rohnert Park will only pay for passing compaction tests meeting the requirements of these specifications. All failing tests will be charged to the Contractor and the costs of such failing tests will be deducted from the contract. In addition, the decision as to when and from what areas tests are to be made will be at the judgment of the Engineer only.

2.14 WORKING HOURS AND RECORD DRAWINGS

Contractor working hours shall be between 8AM and 6PM unless approved by the City Engineer at least 72 hours in advance. Working days shall be Monday through Friday, excluding weekend and holidays.

Record drawings shall be provided at the end of the project by the contractor, and final payment shall not be issued until completed and approved by the project manager. The record drawing compilation shall be considered part of the bid amount.

2.15 PROJECT NOTIFICATION AND IDENTIFICATION SIGN

Contractor shall post notification signs at each residence or commercial establishment within the work limit two (2) weeks prior to commencement of work and three days prior to commencement

of work. Cost for notification shall be considered as part of mobilization, and no additional payment shall be made.

The Contractor shall supply 4' X 8' signs to be displayed at the project site as approved by the Engineer in wording to be provided by the City. The signs shall be constructed in accordance with City STD 742. The contractor shall remove the signs when construction is complete.

2.16 CORONAVIRUS RISKS AND CONSTRUCTION REQUIREMENTS

As of this date of this contract, the extent and impact of Coronavirus (also known as “COVID-19”) on this project, including with respect to supplies, materials, and labor, may not be known by the parties. Nevertheless, Contractor acknowledges the need to reasonably foresee the extent and impact of COVID-19; warrants that it has taken such risks into account in preparing its bid and procuring supplies, materials, and labor; and shall be deemed to have assumed the risks associated with COVID-19 by Contractor’s voluntary entry into this Contract, except as otherwise expressly stated in the Contract Documents.

Contractor hereby acknowledges that it has investigated and is familiar with and shall comply with applicable health orders and construction field safety protocols established by the Health Officer of the County of Sonoma. Contractor shall establish any required Code of Safety Practices and designate a Site Safety Representative as may be required under such orders. Contractor acknowledges that it may be subject to further requirements that may be imposed by State Public Health Officer. Contractor hereby acknowledges that compliance with such requirements constitutes part of the Scope of Work under this Contract.

PART 3 – STANDARD SPECIFICATIONS

**PART 3
CONDITIONS OF THE CONTRACT**

SECTION 1

DEFINITIONS AND TERMS

Whenever in these specifications, or in any documents or instruments where these specifications govern, the following terms, or pronouns in place of them, are used, the intent and meaning must be interpreted as follows (except as the context requires a different meaning):

Abbreviations

AAI	American Asphalt Institute
AASHTO	American Association of State Highway and Transportation Officials
ACI	American Concrete Institute
AISC	American Institute Steel Construction
AISI	American Iron and Steel Institute
API-ASME	American Pressure Institute - American Society of Mechanical Engineers
AREA	American Railway Engineering Association
ASA	American Standards Association
ASTM	American Society for Testing Materials
AWPA	American Wood Preservers Association
AWA	American Welding Society
AWWA	American Water Works Association
CRA	California Redwood Association
DFPA	Douglas Fir Plywood Association
NEMA	National Electrical Manufacturers' Association
WCLA	West Coast Lumbermen's Association

Acceptance

The formal written acceptance by the City of an entire Contract which has been completed in all respects in accordance with the plans and specifications and any modifications thereof previously approved.

Bidder

Any individual, firm or corporation submitting a proposal for the work contemplated, acting directly or through a duly authorized representative.

City

City of Rohnert Park

City Engineer

The City Engineer of the City of Rohnert Park.

Contract or Contract Documents

The Contract or agreement to be entered into by the successful bidder for the performance of the

work must consist of the following documents, each of which is on file in the office of the City Clerk and all of which are incorporated in the Contract and made a part thereof by reference thereto: Contract, Invitation for Sealed Proposals, Instructions and Information to Bidders, Accepted Proposal, Performance Bond, Payment Bond, Special Provisions, Standard Specifications, Design and Construction Standards, Plans, Profiles and Detailed Drawings.

Contractor

The word “Contractor” must mean the person, persons, partnership or corporation entering into a Contract for the performance of the work required and the legal representative of said party of the agent appointed to act for said party in the performance of the work.

Contract Prices

Either the unit prices or lump sum amounts to be named in the Contract, or the total of all payments under the Contract at the unit prices or lump sum amounts, as the case may be. This definition is for convenience and reference only, and must not be construed to alter the fact that the Contract is an entire Contract for the performance of all work depicted on the plans and as described herein.

Directed

Whenever in these specifications the words “directed,” “required,” “permitted,” “ordered,” “instructed,” “designated,” “considered necessary,” “prescribed,” or words of like import are used, it must be understood that the directions, requirements, permission, order, instruction, designation, or prescription, etc. of the City Engineer are intended; and, similarly, the words “approved,” “acceptable,” “satisfactory,” or words of like import, must mean approved by, or acceptable or satisfactory to the City Engineer, unless otherwise stated.

Engineer

Engineer must mean properly authorized engineers, inspectors, and superintendents acting severally within their scope of the particular duties entrusted to them by the City Engineer.

Federal Agencies

Whenever in these specifications reference is made to any Federal Agency or officer, such references must be deemed made to any agency or officer succeeding in accordance with law to the powers, duties, jurisdictions and authority of the agency or officer mentioned.

Inspector

The word “Inspector” must mean the authorized individual or firm acting within the jurisdiction entrusted to it by the City Engineer.

Plans

The Plans must mean collectively all of the drawings or plans referenced by the project specifications and made a part thereof, and also such supplemental drawings or plans as the City Engineer must issue from time to time in order to elucidate drawings or plans attached to these specifications, or for showing details which are not shown thereon, or for the purpose of showing changes in the work, as authorized in later paragraphs describing changes and extra work.

Specifications

The directions, provisions, and requirements contained herein as supplemented by such special provisions or special specifications as may be necessary, pertaining to the method and manner of

performing the work or the quantities and qualities of materials to be furnished under the Contract. The special provisions or special specifications are specified clauses setting forth conditions or requirements peculiar to the project under consideration and covering work or materials involved in the proposal and estimate but not satisfactorily covered by these Standard Specifications.

State

State of California.

Supervision

The word “supervision” where used in these specifications to indicate supervision by the City Engineer must mean the performance of obligations and the exercise of rights specifically imposed and granted upon and to the City in becoming a party to the Contract, of which the text of these specifications form a part. Excepting as specifically stated herein, supervision by the City must not be construed to mean active and direct superintendence of the details of work.

Surety

The word “surety” or “sureties” must mean the bondsmen or party or parties who may guarantee the fulfillment of the Contract by bond, and whose signatures are attached to said bond.

SECTION 2

PROPOSAL REQUIREMENTS AND CONDITIONS

2.1 INTENT

It is the intent of these specifications that the provisions of all sections must apply unless otherwise specified in the Special Provisions, in which case the provisions contained therein must have precedence over those specified in the Standard Specifications. It is also the intent where reference is made to specifications or other organizations for portions of the work, that such reference must apply only to construction methods and materials used in said work.

SECTION 3

AWARD AND EXECUTION OF CONTRACT

3.1 AWARD OF CONTRACT

The City reserves the right to accept or reject any or all proposals and waive technical defects as the best interests of the City may require. Award of the Contract, if it be awarded, will be to the lowest responsive, responsible bidder whose proposal complies with all the requirements prescribed. The award, if made, will be awarded as soon as practicable after the opening of the proposals but not before the time for bid protests set forth below. Proposals in which the prices are obviously unbalanced will be rejected.

The proposals will be compared on a basis of the sum of the totals of the items of the schedule as calculated from the given estimated quantities and the unit prices or lump sums of the amount submitted. The entire work will be awarded to one bidder, unless otherwise specified in the Special Provisions.

3.2 BID PROTESTS

Any bid protest ("Bid Protest") must be filed in writing with the City Clerk, with a copy to the bidder whose bid is being protested, and served by email or facsimile transmission within seven (7) calendar days of the City's issuance of the Notice to Intent to Award for Construction Work. **Proof of service of the Bid Protest must be submitted to the City Clerk within one business day of the filing of the Bid Protest, and any protest without a timely submitted proof of service may be rejected.** The City will use reasonable efforts to deliver by email or facsimile a copy of the Notice of Intent to Award to all bidders who submitted bids no later than the business day after issuance, although any delay or failure to do so will not extend the bid protest deadline described above.

The Bid Protest must state all grounds upon which the protest is based and include all facts and documents in support of each protest ground.

Any bidder whose bid is subject to a protest may submit to the City Clerk a written response ("Response") to the Bid Protest, with a copy to the protesting bidder, and served by email or facsimile transmission within 5 (five) calendar days of the service of the Bid Protest.

The City Clerk shall promptly submit the Bid Protest, and any Response, to the City Manager, Assistant City Manager or his/her designee for decision ("Decision"). The Decision on the Bid Protest shall be in writing and shall be served upon the protesting bidder, and the bidder whose bid is being protested, via email or facsimile transmission within five (5) calendar days of his or her receipt of Bid Protest and any Response. If the City Manager, Assistant City Manager or his/her designee has not issued a written Decision on the Bid Protest within said five (5) calendar day period, then the Bid Protest shall be deemed denied. The Decision, by written Decision or deemed denial, shall be final.

Failure to comply with these Bid Protest Procedures shall be deemed to be a waiver of the right to protest a bid.

3.3 RETURN OF PROPOSAL GUARANTEES

Within 10 days after award of Contract, the City will upon demand return the proposal guarantees

accompanying the proposals of all bidders, except those of the three lowest responsible bidders as determined by the City. Proposal guarantees of such three lowest responsible bidders will be held until the Contract has been finally executed, after which they will be returned to the respective bidders whose proposals they accompany.

3.4 BONDS

Prior to the execution by the City of the Contract, the successful bidder must file good and sufficient bonds to be approved by the City conditioned upon the complete performance of the Contract and upon the payment of claims for labor and materials in connection therewith. The Contractor must pay all premiums and costs thereof and incidental thereto. Such bonds must not be subject to cancellation.

The following minimum thresholds require Payment and Performance bonds for projects over \$25,000.

Payment Bond: Per California Civil Code Section 9550. The payment bond should contain the terms and conditions set forth in Section 9554 of the Civil Code of the State of California, and must be subject to the provisions of that chapter and, in addition, must be in the amounts which are specified in the Special Provisions.

The performance bond must be in an amount specified in the Special Provisions and must be so conditioned as to insure the complete performance of the Contract without exception.

Should any surety or sureties be deemed unsatisfactory at any time by the City, notice will be given to the Contractor to that effect, and he must forthwith substitute a new surety or sureties satisfactory to the City. No further payment must be deemed due or will be made under this Contract until the new surety must qualify and be accepted by the City.

Any alterations in the work to be done, or increase or decrease of the materials to be furnished, which may be made pursuant to the terms of said Contract, must not in any way release either the principal or surety thereunder, nor must any extensions of time granted under the provisions of said Contract release either the principal or surety, and notice of such alterations or extensions of the Contract must be waived by the surety. The bonds must be maintained in full force and effect until the Contract has been completely performed and until all claims for material and labor have been paid.

Once the Notice of Completion has been recorded, Contractor may elect to post a Maintenance Bond equal to 100% of the final Contract Price, including Contract Change Orders, if any, for a period of one-year after the Notice of Completion recorded date.

3.5 EXECUTION OF CONTRACT

The Contract must be signed by the successful bidder and returned, together with the Contract Bonds and valid insurance on City forms, within fifteen (15) calendar days after the date of mailing written notice to the successful bidder that the Contract has been awarded.

3.6 FAILURE TO EXECUTE CONTRACT

Failure to execute a Contract, file acceptable bonds, and/or acceptable insurance as provided herein within said fifteen (15) calendar days shall allow the City, at its discretion, to annul the award and claim the proposal guarantee as provided in the California Public Contract Code. If the successful bidder refuses or fails to execute the Contract, the City may award the Contract to the second lowest

responsible bidder. If the second lowest responsible bidder refuses or fails to execute the Contract, the City may award the Contract to the third lowest responsible bidder. On the failure or refusal of the second or third lowest responsible bidder, to whom any Contract is so awarded, to execute the same, such bidders' guarantees must be likewise forfeited to the City. The work may then be re-advertised or may be constructed by other means as the City may decide.

SECTION 4

SCOPE OF WORK

4.1 WORK TO BE DONE BY CONTRACTOR

The work to be done consists of furnishing all labor, methods or processes, implements, tools, machinery, transportation, insurance, permits, bonds, taxes and materials, except as otherwise specified which are required to remove asphalt concrete and striping, remove concrete curb and gutter, furnish and install concrete sidewalk, median island, and curb ramps, furnish and install new striping, install rectangular rapid flashing beacon assemblies (RRFBs) in complete order for use and to leave the grounds in a neat and orderly condition.

Where items contain a description of work to be included for payment under a particular item, such description must be considered as including, but not being limited to, the work described. It must be further understood that it is the intent that the cost of all work necessary for the completion of the particular item must be included in the price proposal for the item, unless the cost of such work is specifically included in another item.

4.2 FINAL CLEANUP

Before final inspection by the City, the Contractor must clean the site and grounds occupied by it in connection with the work of all rubbish, excess materials, falsework, temporary structures, and equipment, and all parts of the work must be left in a neat and presentable condition. Nothing herein, however, must require the Contractor to remove warning and directional signs prior to formal acceptance by the City.

When the Contractor utilizes a staging area or storage yard that is fenced and screened, final cleanup of the staging area and storage yard will be completed before the fence and screen are removed, except for spot cleanup or trimming that may be required in areas directly under or adjacent to the fence and screen.

4.3 CHANGES IN THE CONTRACT - EFFECT BETWEEN PARTIES

The City reserves the right to make such alterations or deviations, additions to or omissions from the plans and specifications, as may be determined during the progress of the work to be necessary and advisable for the proper completion thereof. When such change is ordered, the City Engineer must determine and state in his/her written order to the Contractor made pursuant thereto whether or not in his/her opinion such change constitutes a material change and what adjustment of consideration provided for in the Contract is warranted. Upon written order of the City Engineer, the Contractor must proceed with the work as so increased, decreased or altered. Such action and any disposition thereof may be taken without notice by City to Insurance Underwriters, Sureties, or Guarantors required by this Contract and absence of notice thereto must in no way whatsoever discharge the obligation of any such party.

When the City and the Contractor fail to agree as to whether an omission of a portion of the work or alterations, or deviations or additions to or omissions from the plans and specifications ordered by the Engineer or City constitute a material change or difference in character of work as herein contemplated sufficient to warrant adjustment in the consideration provided to be paid to the Contractor or fail to agree on the consideration adjustment or compensation to be allowed for such change, the Contractor must forthwith proceed with the changed work upon receipt of written order

from the City Engineer and the following procedures must become operative.

Pending a settlement of the dispute, the Contractor must file with the City Engineer, within ten (10) days after receiving such written notice to proceed, a protest setting forth in detail in what particulars the character of the work was changed so as to warrant a consideration adjustment or by what amount the unit cost or other cost was increased or to what extent the consideration demand or reduction in consideration determined by the City Engineer as warranted is excessive. The failure of the parties to agree must in no wise be construed as relieving the Contractor of its duty and responsibility for continuing with performance under the Contract as changed and filing a protest as above provided for. Failure to continue performance under such circumstances must constitute a breach of Contract by the Contractor and the appropriate provisions hereof with relation thereto must apply. The determination of the City Engineer of the amount of reduction in Contract consideration or other consideration to City or increase in consideration or other basis of compensation to Contractor arising out of any such change must be final and binding upon the Contractor, unless it files such a protest as hereinabove provided within ten (10) days after receiving notice from the City Engineer to proceed. Payment by City on the basis of Contract prices so adjusted must constitute full and final performance of City obligation hereunder. If the parties fail to agree prior to completion of the Contract, final payments must not be delayed but must be made in accordance with the City Engineer's determinations subject to further claim of the Contractor and compliance by City with court order, but nothing contained in this clause must excuse the Contractor from proceeding with the prosecution of the work as changed.

4.3.1 Reduction in Cost

If the cost of work to the Contractor is reduced by reason of any modification of the Contract, compensation must be made to the City therefor or proportionate reduction in Contract consideration must be made therefor.

4.3.2 Quantity Changes

The quantities given in the proposal schedule for unit price items are for comparing proposals and may vary from the actual final quantities. Some quantities may be increased and others may be decreased or entirely eliminated, and no claims must be made against the City for damage occasioned thereby or for loss of anticipated profits, the Contractor being entitled only to compensation for the actual work done at the unit prices proposed.

4.3.3 Extra Work

(a) The City reserves and must have the right, when confronted with unpredicted conditions, unforeseen events, or emergencies, to revise the details of the contemplated work or to add work of a different character or function and have the Contractor perform such revised or added work, as extra work, when such extra work is considered by the City Engineer to be vitally appurtenant to the satisfactory completion of the project. Extra Work is defined as added work of a different character or function and for which no basis for payment is prescribed; or that involving revisions of the details of the work in such a manner as to render inequitable payment under items upon which the Contractor proposed; or that work to be done under stipulated prices as given in the Schedule of Bid Prices.

The signing of the Contract by the Contractor will be deemed to be an agreement on its part to perform extra work, as and when ordered by the City Engineer. The Contractor must give notice to the sureties on the Contractor's bonds if the estimated total value of the Contract, as changed or

supplemented, must exceed the original total proposal price by more than twenty-five percent (25%), but failure to give such notice must in no way whatsoever affect the surety's obligation under said bonds. If required extra work results in delay to the work, the Contractor will be given an equivalent extension of time.

(b) Upon decision of the City to have extra work performed, the City Engineer will so inform the Contractor, acquainting it with the details of the new work. Should an item of work within the proposal schedule correspond with the type of work to be done under extra work to the mutual satisfaction of the Contractor and the City, the extra work must be performed at the stipulated bid price and in the manner provided for said item. Should such extra work not correspond to a stipulated bid price, the Contractor must prepare a price for said work based upon its estimate of cost and submit said price and estimate to the City Engineer based on one of the following methods as requested by the City:

(1) For a stated unit price or lump sum amount based upon current prevailing fair prices for materials, labor, plant, overhead, and profit.

(2) On a cost plus markup basis (force account by the Contractor). All work done by the Contractor on a cost plus markup basis will be computed in the manner hereinafter described, and the compensation thus provided must be accepted as payment in full by the Contractor, and no additional payment will be allowed for the use of small tools, superintendent's services, timekeeper's services, nor any other overhead expenses incurred in the prosecution of the force account work.

Total Cost Must Include:

MATERIALS: For all materials purchased by the Contractor and used in this specific work, it will receive the actual cost less normal discounts of such materials, including freight and delivery charges, as shown by original receipted bills. It must be understood, however, that such salvage value, as may be agreed upon between the City and the Contractor for materials which are not permanently incorporated in the work, will be deducted from the total amount as derived above. The City reserves the right to furnish such materials required as it deems advisable, and the Contractor must have no claim for profit on the cost of such materials.

LABOR: For all direct labor engaged in the specific operation, the Contractor will receive the prevailing wage paid on the project for each and every hour that said labor is actually engaged in such work. In addition, the City will reimburse the Contractor for compensation insurance payments; contributions made to the State as required by the provisions of the Unemployment Reserve Act, Chapter 352, Statutes of 1935, as amended; and for taxes paid to the Federal Government, as required by the Social Securities Act, approved August 14, 1935, as amended.

EQUIPMENT RENTAL: For any machine, power and equipment which is deemed necessary, the Contractor must receive the actual cost of rented equipment furnished by it as shown on its paid vouchers.

For the use of equipment owned by the Contractor, it must be paid the rental rates currently prevailing in the locality, and said rental rates must be deemed to include profit and overhead, and no extra compensation will be allowed, nor will any percentage or amount whatsoever be added thereto.

MARKUP:

(i) **Work by Contractor.** A 15% allowance must be added to Contractor's direct costs and must constitute the markup for all overhead and profit on work by the Contractor. The Contractor must also be compensated for the actual increase in the Contractor's bond premium caused by the extra work.

(ii) **Work by Subcontractor.** When any of the extra work is performed by a Subcontractor, a 15% allowance must be added to the Subcontractor's direct costs and must constitute the markup for all overhead and profit on work by the Subcontractor. In addition, a 5% allowance must also be added to the Subcontractor's direct cost and must constitute the markup for all overhead and profit for the Contractor on work by the Subcontractor. The Contractor must also be compensated for the actual increase in the Contractor's bond premium caused by the extra work.

(c) The Contractor must not commence extra work until it has secured the approval of the City as to the method and amount of payment thereunder, excepting that the City Engineer may, in writing, order the Contractor to proceed with extra work in advance of such approval.

(d) Upon receipt of the Contractor's price, the City Engineer will make an analysis thereof, and the City will adopt one of the following procedures for prosecuting extra work:

(1) Accept the Contractor's price for lump sum or unit price amount in the original or amended form and direct Contractor to proceed with the work; or direct Contractor to perform the work on a cost plus markup basis.

(2) Have the work performed by the City under separate contract, without undue interference or hindrance to the Contractor and without claim or suit by the Contractor for damages on account thereof.

4.4 MAINTENANCE OF DETOURS

The Contractor must construct and maintain detours and detour bridges for the use of public traffic as provided in the Special Provisions, or as shown on the plans or as directed by the Engineer, and payment for such work will be made as set forth in the Special Provisions or at the contract prices for the items of work involved if the work being performed is covered by contract items of work, and no other method of payment therefor is provided in the Special Provisions. Otherwise, the work will be paid for as extra work as specified under Paragraph 4.3 of this section.

When public traffic is routed through the work, provisions for passageway through construction operations will not be considered as detour construction or detour maintenance.

Detours used exclusively by the Contractor for hauling materials and equipment must be constructed and maintained by Contractor at Contractor's expense.

The failure or refusal of the Contractor to construct and maintain detours at the proper time must be sufficient cause for closing down the work until such detours are in satisfactory condition for the use of public traffic.

Where the Contractor's hauling is causing such damage to the detour that its maintenance in a condition satisfactory for public traffic is made difficult and unusually expensive, the Engineer must have authority to regulate the Contractor's hauling over the detour.

4.5 USE OF MATERIALS FOUND ON THE WORK

The Contractor, with the approval of the Engineer, may use in the proposed construction such stone,

gravel, sand or other material suitable, in the opinion of the Engineer, as may be found in the excavation, but it must replace at its own expense with other suitable material all of that portion of the material so removed and used which was contemplated for use in the embankments, backfills, bridge approaches, or otherwise. No charge for materials so used will be made against the Contractor. The Contractor must not excavate or remove any materials from within the project location which is not within the excavation, as indicated by the slope and grade lines, without written authorization from the Engineer.

SECTION 5
CONTROL OF THE WORK

5.1 AUTHORITY OF CITY ENGINEER

The City Engineer must decide all questions which may arise as to the quality or acceptability of materials furnished and work performed and as to the manner of performance and rate of progress of the work and all questions which may arise as to the interpretation of the Plans and Specifications. His/her decision must be final, unless otherwise ordered by the City Manager or Assistant City Manager, and he/she must have authority to enforce and make effective such decisions and orders which the Contractor fails to carry out promptly.

5.2 PLANS

The approved Plans are hereby made a part of these Specifications. These Plans show in general the nature and dimensions of the work to be done. It is hereby understood that changes may be made according to the best interests of the City.

5.3 CONFORMITY WITH PLANS

Finished surfaces in all cases must conform with the lines, grades, cross sections, and dimensions shown on the approved plans. Deviations from the approved plans and working drawings, as may be required by the exigencies of construction, will in all cases be determined by the City Engineer and must be authorized in writing by him/her.

The Contractor must have Plans and Specifications for the project on the project location at all times and must make these Plans and Specifications available to the Engineer upon request.

5.4 WORKING DRAWINGS

The Contractor must submit such working drawings, in quadruplicate, as required by the Special Provisions. Working drawings for any structure must consist of such detailed plans as may be required for the prosecution of the work and are not included in the plans furnished by the City. They must include shop details, erection plans, masonry layout diagrams, and bending diagrams for reinforcing steel, which must be approved by the Engineer before any work involving these plans is performed. Plans for cribs, cofferdams, falsework, centering, and form work will be required and must be subject to approval, unless approval is waived by the Engineer. These plans will be subject to approval insofar as the details affect the character of the finished work, but other details of design will be left to the Contractor, who must be responsible for the successful construction of the work.

It is expressly understood, however, that approval by the Engineer of the Contractor's working drawings does not relieve the Contractor of any responsibility for accuracy of dimensions and details, or for mutual agreement of dimensions and details.

Full compensation for furnishing all working drawings must be considered as included in the prices paid for the various Contract items of work, and no additional allowance will be made therefor.

5.5 COORDINATION OF PLANS, SPECIFICATIONS, AND SPECIAL PROVISIONS

These Specifications, the Plans, Special Provisions, Contract Change Orders, and all supplementary documents are essential parts of the Contract, and a requirement occurring in one is binding as though occurring in all. They are intended to be cooperative and to describe and provide for a complete work.

In case of discrepancy either in the Plans or Specifications, the matter must be promptly submitted to the City Engineer who must make a determination in writing. Any adjustment by the Contractor without this determination must be at its own risk and expense. If the Contractor, in the course of the work, finds any discrepancy in the Plans in the physical conditions of the locality or any errors or omissions in the Plans or in the layout as given by survey points and instructions, it must immediately notify the Engineer in writing who must promptly verify the same. Any work or material not herein specified or shown on the Plans, but which be fair implication in the judgment of the City Engineer, should be included therein, must be done or furnished as a part of the Contract as though shown or included in the Plans or Specifications. Any work done after such discovery, until authorized, must be done at the Contractor's risk.

5.6 INTERPRETATION OF PLANS AND SPECIFICATIONS

Should it appear that the work to be done or any of the matter relative thereto are not sufficiently detailed or explained in the Plans and Specifications, the Contractor must apply to the Engineer for such further explanations as may be necessary and must conform to them as part of the Contract, so far as may be consistent with the original Specifications; and in the event of any doubt or question arising respecting the true meaning of the Specifications, reference must be made to the City Engineer, whose decision thereon must be final.

In the event of any discrepancy between any Plans and the figures written thereon, the figures must be taken as correct.

5.7 SUPERINTENDENCE

Whenever the Contractor is not present on any part of the work where it may be desired to give direction, orders will be given by the Engineer, which must be received and obeyed by the superintendent or foreman or authorized representative who may have charge of the particular work in reference to which the orders are given. Any order given by the Engineer, not otherwise required by the Specifications to be in writing, will, on request of the Contractor, be given or confirmed by the Engineer in writing.

An authorized representative of the Contractor must be present at the site of the work at all times, both while work is actually in progress of the Contract and during periods when work is suspended.

Where the Contractor is comprised of two or more persons, co-partnership or corporations, functioning on a joint venture basis, said Contractor must designate in writing to the City the name of their authorized representative who must have supreme authority to direct the work and to whom orders will be given by the Engineer, to be received and obeyed by the Contractor.

The Contractor must have a sufficient number of superintendents or foremen on the site of the work to adequately supervise and direct each major type of its construction work, and when, in the opinion of the Engineer, the Contractor's required supervisory personnel are considered inadequate, the Contractor, upon request from the City, must promptly provide adequate personnel.

5.8 LINES, GRADES AND MEASUREMENTS

Initial staking out of the work will be done by the Contractor, unless otherwise stated in the Special Provisions. The Contractor will establish control lines and offset lines and set all stakes normally required in order that the Contractor can make the necessary measurements therefrom for the layout of the details of its work without the need for surveyors. Survey stakes and bench marks removed by the carelessness of the Contractor or its employees will be replaced by the City at the Contractor's

expense.

The Contractor must employ skilled personnel for making measurements and skilled mechanics for setting equipment or metal parts that are to be permanently imbedded in or attached to proposed structures. Any inaccuracies in the placing of equipment or metal parts must be remedied by the Contractor at its own cost. Any inaccuracies in the performance of the Contractor's work due to faulty transfer or measurements must be remedied by the Contractor at its own expense.

5.9 INSPECTION

5.9.1 Except as otherwise provided in paragraph 5.9.4 below, all material and workmanship, if not otherwise designated by the Specifications, must be subject to inspection, examination and test by the Engineer at any and all times during manufacture and/or construction and at any and all places where such manufacture and/or construction are carried on. The Engineer must have the right to reject defective material and workmanship or require its correction. Rejected workmanship must be satisfactorily corrected, and rejected material must be satisfactorily replaced with proper material without charge therefor, and the Contractor must promptly segregate and remove the rejected material from the premises. If the Contractor fails to proceed at once with the replacement of rejected material and/or the correction of defective workmanship, the Engineer may by Contract or otherwise replace such material and/or correct such workmanship and charge the cost thereof to the Contractor, or may terminate the right of the Contractor to proceed.

5.9.2 The Contractor must furnish promptly without additional charge, all reasonable facilities, labor, and materials necessary for the safe and convenient inspection and tests that may be required by the Engineer. All inspection and tests by the Engineer must be performed in such a manner as not unnecessarily to delay the work. Special, full size, and performance tests must be as described in the Specifications. The Contractor must be charged with any additional cost of inspection when material and workmanship are not ready at the time inspection is requested by the Contractor.

5.9.3 Inspection of material and finished articles to be incorporated in the work at the site must be made at the place of production, manufacture, or shipment, whenever the quantity justifies it, unless otherwise stated in the Specifications; and such inspection and written or other formal acceptance, unless otherwise stated in the Specifications, must be final, except as regards latent defects, departures from specific requirements of the Contract, damage or loss in transit, frauds, or such gross mistakes amount to fraud. Subject to the requirements contained in the preceding sentence, the inspection of material and workmanship for final acceptance as a whole or in part must be made at the site. Nothing contained in this paragraph must in any way restrict the City's rights under any warranty or guarantee. No work must be covered by a succeeding operation until the Engineer has had adequate notice and a sufficient opportunity to inspect the work. Any violation of this requirement will be deemed an attempt to defraud the City, and the work covered may be rejected. The Contractor must comply promptly with the instructions of the Engineer. Failure to so comply must be sufficient cause for breach of Contract. The Engineer may, when in the best interests of the City, order a suspension of the work or any part of the work which is not, in his/her opinion, proceeding satisfactorily.

The inspection of the work must not relieve the Contractor of any of its obligations to fulfill its Contract as prescribed.

5.9.4 Should it be considered necessary or advisable by the Engineer at any time before final acceptance of the entire work to make an examination of work already completed, and upon which

adequate notice and sufficient opportunity for inspection was as provided in the previous paragraph, by removing or tearing out same, the Contractor must on request promptly furnish all necessary facilities, labor, and material. If such work is found to be defective or non-conforming in any material respect due to fault of the Contractor or its Subcontractors, it must defray all the expense of such examination and of satisfactory reconstruction. If, however, such work is found to meet the requirements of the Contract, the actual direct cost of labor and material necessarily involved in the examination and replacement, plus markup as determined in Section 4.3, must be allowed the Contractor, and it must, in addition, if completion of the work has been delayed thereby, be granted a suitable extension of time on account of the additional work involved.

5.9.5 All inspection by the City, the Engineer, or the Engineer's representative is for the use by the City in determining the acceptability of the project by the Engineer. The Contractor is responsible for the quality of all materials supplied and all workmanship. The Contractor must provide and implement a quality control program independent of the inspections provided by the City. Such quality control program must be designed to ensure materials and workmanship are of first quality in conformance with these specifications and the best practices of the construction industry. The contractor's quality control plan must be submitted to the Engineer for review within 15 days of Notice to Proceed. Approval of the quality control plan by the Engineer does not relieve the contractor of providing sufficient tests or certifications to provide a complete and useable product in accordance with these specifications.

5.10 UNAUTHORIZED WORK AND DEFECTIVE WORK OR MATERIALS

Any work done beyond the scope of the Plans, Specifications, established by the City Engineer, or any extra work done without written authority, will be considered as unauthorized and will not be paid for. Work so done may be ordered removed at the Contractor's expense. Upon failure on the part of the Contractor to comply promptly with any order of the Engineer made under the provisions of this Section 5, the City Engineer must have authority to cause defective work or materials to be remedied or removed and replaced, and unauthorized work to be removed, and to deduct the cost from any moneys due or to become due the Contractor notwithstanding that such defective work and materials have been previously overlooked by the Engineer and accepted or estimated for payment.

5.11 METHODS AND EQUIPMENT

Equipment not suitable to produce the quality of work required will not be permitted to operate on the project. If the City Engineer or representative observes unsuitable equipment, the City Engineer shall have the right and authority to stop work. Contractor shall not be granted extra additional days or compensation for delay due to Contractor's use of unsuitable equipment.

Plants must be designed and constructed in accordance with general practice for such equipment and must be of sufficient capacity and of such character to insure the production of sufficient material to carry the work to completion within the time limit.

The Contractor must provide adequate and suitable equipment and plants to meet the above requirements and, when ordered by the Engineer, must remove unsuitable equipment from the work and discontinue the operation of unsatisfactory plants.

Each machine or unit of equipment must be operated by a person experienced in handling the particular make of machine or unit of equipment in use, at a speed or rate of production not to exceed that recommended by the manufacturer.

All vehicles used to haul materials over existing highways must be equipped with pneumatic tires. Beam scales for use in batchers, proportioning plants, platform scales, or for other purposes must be equipped with “V” blocks and pivots of hard steel in all hangers or other points of support which are used as parts of the weighing mechanism.

5.12 FINAL INSPECTION AND ACCEPTANCE

The work will be inspected by the City for acceptance promptly upon receipt of notice in writing, for the Contractor, that the work required under the Contract has been performed.

If, in the judgment of the City Engineer, the work has been completed in accordance with the Plans and the Specifications and is ready for acceptance, he/she will so certify and accept the completed work in accordance with the City’s approved procedures. The City Engineer will, in his/her certification to the City, give the date upon which the work was completed. Upon acceptance by the City pursuant to such certification, the date of completion as certified by the City Engineer will be the date of completion of work up to which penalties for liquidated damages, if any, will be computed.

5.13 CLEANUP WORK

During construction the Contractor must keep the site reasonably free and clear from all rubbish and debris. Care must be taken to prevent spillage when hauling is being done on any public road or street, and any such spillage or debris resulting from the Contractor's operation must be immediately cleaned up.

Upon the completion of the work, the Contractor must remove all plants, building, rubbish, unused materials, concrete forms and other like material belonging to it or used under its direction during the construction. In the event of its failure to do so, the same may be removed by the City at the expense of the Contractor.

SECTION 6

CONTROL OF MATERIALS

6.1 CITY-FURNISHED MATERIALS

The Contractor must notify the City as to the time at which it will require those materials which are to be furnished by the City. This notice must be given in sufficient advance of actual need to avoid delay.

City-furnished materials will be delivered Freight on Board (f.o.b.) trucks at the site of the work. The site of the work must be construed as meaning the nearest point to the work which is readily accessible to trucks. The Contractor will be charged with any standby or demurrage charges which may accrue at the point of delivery because of his failure to unload the trucks immediately upon their arrival at the site of work.

The Contractor must receive and be responsible for these materials, storing those which may be damaged by the elements, in a safe, substantial manner until they are used in the work.

Any materials delivered in an acceptable condition to the Contractor by the City and subsequently lost to or rejected by the City due to damages from handling, transporting, storing, flood waters, fire, or for any other reasons before its acceptance in the completed work, must be paid for by the Contractor. The total value of such materials will be deducted from moneys due or becoming due the Contractor. Any condemned material must be immediately and permanently removed from the site of work by the Contractor.

Any of the City's materials, remaining unused after all requirements for said materials have been met, must be promptly returned to the City in acceptable condition. These materials must be returned by the Contractor f.o.b. the City's truck at the site of work and at such points as will be conveniently accessible to City transportation.

The Contractor must not sell, assign, mortgage, hypothecate, or remove equipment or materials which have been installed or delivered and which may be necessary for the completion of the Contract, without the formal consent of the City.

6.2 MATERIALS TO BE FURNISHED BY THE CONTRACTOR

Unless otherwise specified herein, or on the Plans and Specifications, the Contractor must furnish all materials required for the completion of the Contract. The cost of hauling, storing and handling of all the materials required to be furnished by the Contractor must be included in the unit price proposal in the schedule for the work for which the materials are required.

6.3 SOURCE OF SUPPLY AND QUALITY OF MATERIALS

It must be the Contractor's responsibility to require material suppliers and Subcontractors to furnish materials which meet the requirements of the Specifications. All materials which are to become part of the completed project must be new and must conform to the requirement prescribed therefor in these Specifications or as specified in the Special Provisions.

Unless otherwise waived in writing by the Engineer, the Contractor will be required to furnish the City with certification prepared and signed by the manufacturer and/or supplier to the effect that items furnished meet all the requirements of the Specifications. Such certification must be furnished prior to the use of the material in any part of the construction.

In the case of sand and gravel to be used for concrete construction, the Contractor must notify the City's representative in writing, the sources of the available materials and secure source approval in writing prior to placing order for delivery of this material to the job site.

6.4 WATER AND ELECTRIC POWER

Unless otherwise indicated in the proposal schedules, the responsibility must be upon the Contractor to provide, pay all cost for, and maintain at his own expense an adequate supply of water and electric power of a quality suitable for its construction and domestic purposes.

The Contractor must indemnify, defend, and save harmless the City against any and all claims or suits for damages arising from its acquisition and use of electric power and water.

6.5 MATERIALS AND WORKMANSHIP; WARRANTY

All material furnished by the Contractor must be of the specified quality and equal to approved samples, if samples have been submitted. All work must be performed and completed in a thorough, workmanlike manner, notwithstanding any omission from the Plans and Specifications. All work done and all materials furnished must comply with these Specifications to the satisfaction of the City.

Materials furnished by the Contractor and condemned by the Engineer as being unfit for use must be immediately and permanently removed from the site of work. Unused materials, except such as furnished by the City, must remain the property of the Contractor.

Contractor warrants that all construction services shall be performed in accordance with generally accepted professional standards of good and sound construction practices, all Contract Documents requirements, and all laws, codes, standards, licenses, and permits. Contractor warrants that all materials and equipment shall be new, of suitable grade of their respective kinds for their intended uses, and free from defects. Contractor hereby grants to City for a period of one year following the date of completion its unconditional warranty of the quality and adequacy of all of the Work including, without limitation, all labor, materials and equipment provided by Contractor and its Subcontractors of all tiers. If either prior to completion of the Work, or within one year after completion, any Work (completed or incomplete) is found to violate any of the foregoing warranties (Defective Work), Contractor shall promptly, without cost to City and in accordance with City's written instructions, correct, remove and replace the Defective Work with conforming Work, and correct, remove and replace any damage to other Work or other property resulting therefrom. If Contractor fails to do so, Contractor shall pay all of the City's resulting claims, costs, losses and damages. Where Contractor fails to correct Defective Work, or defects are discovered outside the correction period, City shall have all rights and remedies granted by law.

6.6 STORAGE OF MATERIALS

Materials must be so stored as to insure the preservation of their quality and fitness for the work. When considered necessary by the Engineer, they must be placed on wooden platforms or other hard, clean surfaces and not on the ground. They must be placed under cover when so directed. Stored materials must be so located as to facilitate prompt inspection.

6.7 SAMPLES AND SPECIMENS

The Contractor must submit specimens or samples of materials to be used in the work as the

Engineer may require.

6.8 TRADE NAMES AND ALTERNATIVES

For convenience in designation on the Plans or in the Specifications, certain equipment or articles or materials may be designated under a trade name of a manufacturer and its catalogue information. The use of alternative equipment or an article or material which is of equal quality and of the required characteristics for the purpose intended will be permitted, subject to the approval of the City Engineer, in accordance with the following requirements:

The burden of proof as to the comparative quality and suitability of alternative equipment or articles or materials must be upon the Contractor, and it must furnish, at its own expense, all information necessary or related thereto as required by the City Engineer. The City Engineer must be the sole judge as to the comparative quality and suitability of alternative equipment or articles or materials, and his/her decision must be final.

The price proposal by the Contractor is assumed to be on the basis of trade names specified or designated in the Specifications. Savings resultant from use of a less expensive equal or alternate must accrue to the City and must be subtracted from the unit price for this item.

6.9 REMOVAL OF EQUIPMENT OR MATERIALS

The Contractor must not sell, assign, mortgage, hypothecate or remove equipment or materials which have been installed or delivered and which may be necessary for the completion of the Contract without the formal consent of the City.

6.10 TESTING OF MATERIALS

Unless otherwise specified elsewhere in the Specifications or in the Special Provisions or called for in the Plans, all tests of materials and work for determining compliance with specified requirements must be performed by the City or its authorized representative.

SECTION 7

LEGAL RELATIONS AND RESPONSIBILITY

7.1 LAWS TO BE OBSERVED

The Contractor must keep itself fully informed of all existing and future State and Federal laws and County and municipal ordinances and regulations which in any manner affect those engaged or employed in the work, or the materials used in the work, or which in any way affect the conduct of the work, and of all such orders and decrees of bodies or tribunals having any jurisdiction or authority over the same. The contractor must at all times observe and comply with all such existing and future laws, ordinances, regulations, orders, and decrees of bodies or tribunals having any jurisdiction or authority over the work; and must indemnify, defend, and save harmless the City and all its officers, agents and servants against any claim or liability arising from or based on the violation of any such law, ordinance, regulation, order, or decree, whether by itself or its employees. If any discrepancy or inconsistency is discovered in the Plans, Drawings, Specifications, or Contract for the work in relation to any such law, ordinance, regulation, order or decree, the Contractor must forthwith report the same to the City Engineer in writing.

7.2 PERMITS

The City will obtain all necessary rights and approvals for the work to occupy properties in streets, highways or railways. The Contractor must obtain all permits and pay any fees connected therewith having to do with its construction operations. The Contractor must furnish the City with a copy of all permits and must fully comply with all conditions and provisions of same.

Bidders must contact railway companies affected by the work under the project and ascertain their requirements in respect to indemnification agreements, bonds and insurance. Upon award of Contract, the Contractor must immediately again contact the railway company and, if required, enter into an indemnification agreement, and furnish bonds and insurance, and pay the fees therefor.

All expenses incurred by the railway company as a result of the Contractor's operations must be borne by the Contractor.

7.3 PATENT CLAIMS

The bidder must include in the price proposal for the work the patent fees or royalties or charges upon any patented article or process which it may furnish or use in the prosecution of the work, and the bidder to whom the Contract is awarded must indemnify, defend and save harmless the City against any legal action that may be brought for infringement of patents upon any articles or processes that may be used by it in the prosecution of the work. The contractor must furnish satisfactory evidence of release of all claims of this nature before the final payment is made upon the Contract.

7.4 SANITARY PROVISIONS

The Contractor must provide and maintain in a neat and sanitary condition such accommodations for the use of its employees as may be necessary to comply with all applicable laws, ordinances and regulations pertaining to the public health and sanitation of dwellings and camps. Enclosed toilets must be provided for the use of the persons employed or engaged on any work under these Specifications.

7.5 RIGHT OF WAY AND RIGHT OF ACCESS

The City will acquire all permanent rights of way or permanent easements required for the constructed project. The Contractor is hereby empowered to use the site for the purposes described in the Specifications.

The responsibility for obtaining the right to enter, remove, alter, or make use of any existing road, culvert, bridge, canal, pipeline, levee, fence or similar barrier, lines of communications or improvement of any nature, or the trespassing on privately owned lands, must be in the hands of the Contractor, and it must indemnify, defend and save harmless the City from any and all claims for such damages occasioned by such entering, removing, altering, using or trespassing.

In case of interference to the work by delay of the City in furnishing permanent rights of way or permanent easements, the Contractor will be allowed an extension of time equivalent to the time lost by unavoidable delay in the completion of the Contract because of the failure to furnish the rights of way on time, but no damages will be allowed or paid for such delay.

Rights of way and/or easements and construction easements have been secured for work sites, and for trails and roadways as considered necessary for ingress and egress to the work site. Such rights and/or easements have been delineated on the Plans. The right to enter, remove, alter, or otherwise make use of adjacent property, roads, utility lines, fences, vegetation and other improvements as not included within the rights of way or easements must be at the sole expense and responsibility of the Contractor.

7.6 PUBLIC CONVENIENCE AND ACCESS

The Contractor must conduct its operations so as to cause the minimum obstruction and inconvenience to traffic and to places of business and residence adjacent to the work. No greater quantity of work must be under construction at any one time than can be properly conducted with due regard for the rights of the public. Where existing streets are not available as detours, all traffic must be permitted to pass through the work with as little inconvenience and delay as possible, unless otherwise provided or authorized. If half the street only is under improvement, the other half must be conditioned and maintained as a detour.

The work must be conducted by tunneling, backfilling or bridging where necessary to provide access to fire hydrants and water gates; driveways to service stations, markets or other places of business requiring public vehicular access; and driveways to private residences, unless the Contractor makes other arrangements satisfactory to the City. Temporary approaches to intersecting streets and alleys must be provided and maintained in good condition. Safe crossings for pedestrians must be provided at intervals of not more than 300 feet.

7.7 STORAGE OF MATERIALS IN PUBLIC STREETS, ROADS OR HIGHWAYS

Construction materials must not be stored in streets unless permitted by the City Engineer.

7.8 PUBLIC SAFETY

Attention is called to the “Construction Safety Order,” “Trench Construction Safety Orders,” “General Safety Orders,” and “Tunnel Safety Rules” of the California Division of Occupational Safety and Health to which the Contractor is required by law to conform. The contractor must provide itself with copies of these rules and orders and must keep a copy of each at the site of its operations and must be governed by the requirements thereof. The requirements concerning Ventilation, General Safety Precautions, Transportation, Roof Inspection, Timbering, and all rules and regulation concerning the use of explosives are of particular importance.

7.9 STREET CLOSURES, DETOURS, BARRICADES

In addition to the requirements of this paragraph and Section 4 of these Specifications, the Contractor must, unless otherwise permitted by the City Engineer, conform to the requirements for street closures, detours and barricades as stipulated in the Special Provisions. However, the City Engineer may permit deviations from the requirements stipulated therein when such deviations are to the best interests of the City and are approved by the County, City or State authorities concerned.

During the progress of the work, adequate provisions must be made by the Contractor to accommodate the normal traffic along streets and highways immediately adjacent to or crossing the work so as to cause a minimum of inconvenience to the general public.

The Contractor must give due notice to local police and fire departments prior to beginning construction and must cooperate with said departments in complying with their requirements pertaining to emergency vehicles and equipment.

The Contractor must comply with the requirements of the County, City or State authorities concerned in regard to their requirements for closure of streets; the providing of barriers, guards, lights, temporary bridges, flagmen and watchmen; and the posting of proper notices or signals to the public regarding detours and the condition of the work under construction so as to effectively guard the public from danger as a result of the work being done under the Contract. The Contractor must fully comply with such requirements. The Contractor must also be held responsible for compliance with any additional requirements as may arise during the progress of the work. All costs involved in respect to the above requirements will be considered as included in the prices proposal for the various items of work.

The Contractor must furnish, install, and upon completion of the work, remove all signs and warning devices required for directing and protecting the public during construction.

The signs and posting thereof must conform to the current requirements as specified in the manuals covering signs published by the Division of Highways, Department of Public Works of the State of California. Copies of these manuals are on file in the office of the Engineer.

The Contractor must notify the appropriate authorities of any municipality or unincorporated area 24 hours in advance of the start of any construction work being done in said municipality or area.

The provisions of Paragraph 7.18, "Emergencies and Responsibility for Damage," must apply to the precautions and safeguards taken by the Contractor in connection with the closure of streets, barricades, detours, signs, etc., as required by the above authorities.

7.10 USE OF EXPLOSIVES

The use of explosives will not be permitted unless otherwise stated in the Special Provisions. If permitted, the method employed and the quantity of explosives used must at all times be subject to the approval of the Engineer. Explosives must be handled, used and stored in accordance with the provisions and requirements of all applicable laws, ordinances and regulations with respect thereto.

The approval by the Engineer for the use of explosives must not relieve the Contractor from its responsibility to indemnify, defend and save harmless the City from any legal actions or claims brought against it because of or on account of the use of explosives.

7.11 PRESERVATION OF PROPERTY

The Contractor must be held responsible for the protection of the restoration of, or the replacement

of, any improvements such as, but not limited to, lawns, trees, shrubs, hedges, fences, walls, sidewalks, driveways, curbs, gutters and pavement existing on public or private property at the start of work or placed there during the progress of work and not being specified or shown on the drawings to be either temporarily or permanently removed. The Contractor must be held responsible for the removal of all USA Markings created within the project limits, and in relation to the project. Replacement or restoration must meet the approval of the Engineer.

With respect to trees, the Contractor must obtain permission from the Engineer and from the jurisdictional agency concerned prior to the removal or trimming of any trees, except where a tree is specifically indicated on the Plans or in the Specifications to be removed. Trees which are so indicated need not be replaced except where otherwise stipulated in the Specifications.

All costs involved in the protection and restoration of existing improvements as herein specified must be included in the prices proposal for the various items of work.

7.12 PRESERVATION OF MONUMENTS

The Contractor must not disturb any monuments or stakes found on the line of improvements without permission from the Engineer, and must bear the expenses of resetting any monuments or stakes which may have been disturbed with such permission. The Contractor must reset all street signs and traffic signs disturbed by it during the progress of the work.

7.13 SAFEGUARDING EXCAVATIONS AND STRUCTURES

In making excavations for the project, the Contractor must be fully responsible for providing and installing adequate sheeting and/or timbering and bracing as may be necessary as a precaution against slides or cave-ins, and to protect all existing improvements of any kind, either on public or private property, full from damage. The Contractor must make necessary repairs to or reconstruction of any such improvements damaged at its own expense and as directed by the Engineer.

The Contractor must remove all shattered rock or other loose material which appears dangerous to workmen or to structures. The fact that such removal may enlarge the excavation beyond the required limits must not operate to relieve the Contractor from the necessity of making such removal, and the Contractor must be entitled to no additional compensation under any Contract item on account of such removal and enlargement.

All material required for sheeting, bracing and shoring must be furnished by the Contractor and upon completion of the work, except for such as may be left in place, must become the property of the Contractor.

7.14 EMERGENCIES AND RESPONSIBILITY FOR DAMAGE

The Contractor, at all times throughout the performance of the Contract, must take all precautions necessary to effectually prevent any accident or other cause of damage to life or property in any place affected by the operations in consequence of work being done under the Contract and in consequence of any unusual conditions which may arise, and must to this end erect and maintain suitable and sufficient barriers, signs, lights, or other necessary protection. This requirement must also apply to interruption or contamination of public water supply, irrigation, or other public services, or from the failure of partly completed works.

If, in the opinion of the Engineer, the precautions taken by the Contractor are not safe or adequate at any time during the life of the Contract, he/she may order the Contractor to take further precautions, and if the Contractor must fail so to do, the Engineer may order the work done by the

City forces and charge the Contractor for the cost thereof, such cost to be deducted from any moneys due or becoming due the Contractor. Failure of the Engineer to order such additional precautions, however, must not relieve the Contractor from its full responsibility for public safety.

The Contractor must indemnify, defend and save harmless the City from any legal actions or claims of every name and description brought against it for, or on account of, any injury or damage to person or property received or sustained by any person or persons by or from the Contractor, or any duly authorized Subcontractor or any agent, employee or workman, by or on account of work done under the Contract of any extension or addition thereof caused by its negligence, or by or in consequence of any negligence in guarding the same, or any material used or to be used for the same, or by or on account of any material, implement, appliance or machine used in the construction, or by or on account of any accident or of any act or omission of the Contractor, or of any duly authorized Subcontractor or any agent, employee or workman.

A sufficient amount of the money due the Contractor under the Contract as must be determined to be necessary by the City may be retained until all legal actions or claims for damages as aforesaid have been settled and evidence to that effect has been furnished to the City. This amount may be retained in addition to that provided for in Paragraph 9.5.

All of the above provisions must include suits for loss of business and/or obstruction or inconvenience to business or private property owners.

7.15 DISPOSAL OF MATERIAL OUTSIDE OF CITY'S RIGHT OF WAY

Unless otherwise specified in the Special Provisions, the Contractor must make its own arrangements for disposing of materials outside of City's right of way at its own profit or loss, and it must pay all costs involved therewith.

When any material, including excess or unsuitable excavated earth or other materials are to be disposed of outside of City's right of way, the Contractor must first obtain written permit from the property on whose property the disposal is to be made, and it must file said permit or a certified copy thereof, together with a written release from the property owner, absolving the City from any and all responsibility in connection with disposal of material on said property.

Unless otherwise provided in the Special Provisions, full compensation for all costs involved for disposing of materials, as above specified, must be considered as included in the prices paid for the various Contract items of work, and no additional allowance will be made therefor.

7.16 CONTRACTOR'S RESPONSIBILITY FOR WORK

The submitting of a proposal hereunder must be considered as evidence that the bidder has carefully examined the site of the work with regard to the climatic and physical conditions which will affect construction operations.

The Contractor must, throughout the entire term of the Contract, assume all risks and expense of interference and delay in its operations, and the protection from or the repair of damage to improvements being built by it under the Contract as may be caused by water of whatever quantity from floods, storms, industrial waste, irrigation, underground, or other sources. The Contractor must also assume full responsibility and expense of protecting or removing and returning to the site of work all equipment or materials under its care endangered by any action of the elements.

Furthermore, the Contractor must indemnify, defend and save harmless the City against all claims or suits for damage arising from his operations in dewatering the work and control or diversion of

water.

All works installed by the Contractor in connection with dewatering, control, and diversion of water, but not specified to become a permanent part of the project, must be removed and the site restored, insofar as practical, to original condition at the Contractor's own expense.

7.17 CITY ENGINEER CANNOT WAIVE OBLIGATIONS

It is expressly agreed that neither the City Engineer nor any of his/her agents must have the power to waive any of the obligations of these Specifications for the furnishing by the Contractor of good and suitable material and for performing the work as herein described. Failure or omission on the part of the City Engineer, or any of his/her assistants or agents, to condemn defective or inferior work or materials, must not imply acceptance of the work, nor release of the Contractor from obligations at once to tear out, remove and properly replace the same without compensation, at its own cost and expense at any time, upon the discovery of said defective work and material, prior to the final acceptance of the entire Contract; neither must such failure or omission nor any acceptance by the City or by the City Engineer or any other officer or employee of the City be construed as barring the City at any subsequent time from recovery of damages from the Contractor and its sureties, and of such a sum of money as may be needed to remove and to build anew all portions of the work in which fraud was practiced, or improper work or material hidden.

7.18 RIGHTS IN LAND IMPROVEMENTS

Nothing in these Specifications must be considered as allowing the Contractor to make any arrangements with any person to permit occupancy or use of any land, structure or building within the limits of the Contract for any purpose whatsoever, either with or without compensation, in conflict with any agreement between the City and any owner, former owner, or tenant of such land, structure or building.

7.19 PERSONAL LIABILITY

Neither the City, the City Engineer, nor any of his/her agents or other officer or authorized employee of the City must be personally responsible for any liability arising under the Contract. The Contractor must maintain in full force and effect, during the entire life of the Contract, public liability, property damage and personal injury insurance in amounts not less than specified in the Special Provisions. The Contractor must maintain on file with the City during the entire life of the Contract a memorandum of coverage or other evidence of such insurance, issued by the underwriter. Said insurance referred to must not be cancelled or renewal thereof declined unless notice is mailed to the named insured at least 45 days prior to the effective date or renewal or at least 60 days prior to the effective date of cancellation. In addition, if a public agency is named as an additional insured by way of endorsement or certificate of insurance, notice should be given to said public agency. The Contractor must pay all premiums whether said premiums cover extra work or work under regular contract items.

7.20 REPAIR OF EQUIPMENT

The work of installing, assembling, repairing or reconditioning, or other work of any nature on machinery, equipment, or tools used in or upon the work must be considered a part of the work to be performed under the Contract, and any laborers, workmen, or mechanics working on such machinery, equipment or tools, unless employed by bonafide commercial repair shops, garages, blacksmith shops, or machine shops, which have been established and operating on a commercial basis for a period of at least two months prior to the award of the Contract, must be subject to all of

the requirements relating to labor set forth herein and in these Provisions.

7.21 CONTRACTOR'S LEGAL ADDRESS

The address given in the proposal must be considered the Contractor's legal address, but this may be changed at any time by notice in writing to the City at its office. The delivery to such address, or the depositing in the United States mails in a sealed envelope, postpaid, registered and properly directed to the Contractor's legal address, of any communications must be considered a legal and sufficient service of the same upon the Contractor.

7.22 COOPERATION AND COLLATERAL WORKS

Where two or more contractors are employed in related or adjacent work, each must conduct its operations in such manner as not to cause any unnecessary delay or hindrance to the other. Each contractor must be responsible to the other for all damage to work, to person or property, or for loss caused by failure to finish the work within the specified time for completion.

The Contractor must also coordinate its work and cooperate with contractors or workmen employed by other agencies on or adjacent to the site of the work.

7.23 UTILITIES

Utilities for the purpose of these specifications must be considered as including, but not limited to, pipelines, conduits, transmission lines, and appurtenances of "Public Utilities" (as defined in the Public Utilities Act of the State of California) and those of private industry, businesses, or individuals solely for their own use or for use of their tenants; and storm drains, sanitary sewers, street lighting, and traffic signal systems.

All utility service interrupted or severed by the Contractor's operation must be immediately reinstated by temporary connections, and permanent reconstruction must be made as soon as construction operations permit.

The City has, by a search of known records, endeavored to locate and indicate on the drawings, all utilities which exist within the limits of the work. However, the accuracy or completeness of the utilities indicated on the drawings is not guaranteed. Service connections to adjacent property may or may not be shown on the drawings. It must be the responsibility of the Contractor to determine the exact location of all utilities and their service connections. The Contractor must make its own investigation as to the location and type of existing utilities and their appurtenances and service connections which may be affected by the Contract work and must notify the City as to any utility located by it which has been incorrectly shown or omitted from the drawings.

Work required in connection with utilities because of interference with Contract work will be performed and paid for as specified in the following paragraphs, 7.27.1 through 7.22.8; however, when directed or approved by the City Engineer, changes in line or grade of structure being built may be made in order to avoid utilities. The cost of such changes will be paid for as extra work.

7.23.1 By Other Than the Contractor:

When it is stated in the Special Provisions or indicated on the drawings that a utility is to be relocated, altered, or reconstructed by other than the Contractor, the City will conduct all negotiations with the owners in respect to such work, and the work will be done at no cost to the Contractor.

7.23.2 By the Contractor Under A Specified Contract Item:

When the bidding schedule contains a separate item covering the relocation, alteration, or reconstruction of a utility by the Contractor, the price proposal for said item must cover all costs involved in such work.

The utility owner's drawings and Special Provisions will give the construction details for the work, and, unless the time at which the work must be done is specified in the Special Provisions, the Contractor must coordinate with the utility owner in respect to when the work is to be done.

7.23.3 By the Contractor But Not Under a Specified Contract Item:

When work on a utility is specified or indicated on the Plans to be done by the Contractor, but is not included as a separate Contract item in the bidding schedule, the City will make all arrangements with owner of the utility in respect to the construction details; however, the Contractor must coordinate with the utility owner as to when the work is to be done. Any costs for such work must be absorbed in the unit prices or included in the lump sum amounts proposal for the various Contract items.

7.23.4 By the Contractor - Service Connections:

The alteration, temporary relocation or reconstruction of service connections to adjacent property must be the responsibility of the Contractor, and the contractor must notify occupants of the affected properties before service is interrupted and make all arrangements with the utility owners regarding requirements of interruption and reconstruction of service connections. The costs for such work on service connections must be absorbed in the unit prices or included in the lump sum amounts proposal for the various Contract items, unless otherwise specified in the Special Provisions. Reconstruction of sanitary sewer house connections must be accomplished in the manner shown on the Plans.

7.23.5 By the Contractor for His Own Convenience:

The temporary relocation or the alteration of any utility desired by the Contractor solely for its own convenience in the performance of the Contract work to a position or condition other than that provided for in the Special Provisions or shown on the Plans must be the Contractor's own responsibility, and the contractor must make all arrangements with the owners of the utility regarding such work. Any cost of such work for the Contractor's own convenience must be absorbed in the unit prices or included in the lump sum amounts proposal for the various Contract items.

7.23.6 By the Contractor or by Others – Unknown Utilities Disclosed during Contract Work:

In the event that a utility is disclosed subsequent to the award of Contract, such utility not being indicated on the drawings, the alteration, relocation, or proper support and protection must be done and paid for as follows:

7.23.6.1 When said utility is found to occupy the space required to be occupied by a part of the permanent works to be constructed under the Contract, or when said utility is more or less parallel with the conduit and, in the case of the pipe conduit, found to be within vertical planes of each side of the pipe a distance away from the pipe equal to ten inches for pipe 96 inches or less in diameter and equal to twelve inches for pipe greater than 96 inches in diameter or to be within the specified excavation pay lines (when such are specified or shown on the drawings), the City will arrange for the relocation or alteration of said utility or require the Contractor to do same as extra work. However, when said utility is found to cross the excavation laterally, but not to intercept the

permanent works to be constructed, then the Contractor will be required to maintain the utility in place at its own expense.

7.23.6.2 When said utility is more or less parallel with and any portion of it does not lie within the vertical planes specified hereinabove (for pipe conduit) or does not lie within the excavation pay lines (when such are specified or shown on the drawings), the Contractor must advise the City thereof, and, in cooperation with the City, provide and place the necessary support for proper protection to insure continuous and safe operation of the utility structure. All costs for such work must be borne by the Contractor, unless it is ascertained by the City that the utility's franchise is such as to require the utility to bear such costs, in which case it must be the responsibility of the Contractor to secure enforcement of said franchise if it so desires.

7.23.7 Responsibility of the Contractor

The Contractor must be held responsible for all costs for the repair of any and all damage to the Contract work or to any utility (whether previously known or disclosed during the work), as may be caused by its operations. Utilities not shown on the drawings to be relocated or altered by others must be maintained in place by the Contractor. Utilities which are relocated by others in order to avoid interference with structures and which cross the project work must be maintained in their relocated positions by the Contractor.

At the completion of the Contract work, the Contractor must leave all utilities and appurtenances in a condition satisfactory to the owners and the City.

7.23.8 Delays Caused by Failure to Relocate Utilities

Where parties other than the Contractor are responsible for the relocation of utilities, in accordance with the provisions of these Plans and Specifications, and a delay in the Contractor's work is caused by the failure on the part of said parties to remove or relocate such utilities in time to prevent such delay. It must be understood that the Contractor must not be entitled, as a result of such delay to its work, to damages or additional payments over and above the Contract price. If delays in the Contractor's work are caused by the reason mentioned hereinabove, the Contractor must be entitled to an extension of time. The length of such extension of time will be determined by the City, with consideration as to the effect of the delay on the project as a whole.

In order to minimize delays to the Contractor caused by the failure of other parties to relocate utilities which interfere with construction works, the Contractor, upon request to the City, may be permitted to temporarily omit the portion of work affected by the utility. The portion thus omitted must be constructed by the Contractor immediately following the relocation of the utility involved. Should the omitted portion of the work consist of concrete pipe, the Contractor may complete said portion by constructing a field joint.

Unless otherwise specified, where sewers, drainage water, gas or any other conduits and related structures and appurtenances which have been abandoned or which are to be abandoned as a result of the construction of this project are found to interfere with construction, the interfering portions must be removed and the remaining exposed portions sealed with either a wall of concrete not less than six inches thick. All salvable castings or steel parts which interfere with construction must be removed, and the Contractor must contact the owners and, if required, must deliver such materials f.o.b. the owner's trucks at the site of the work; otherwise, such material must become the property of the Contractor and must be disposed of by the contractor away from the site of work.

The cost of all such work must be absorbed in the prices proposal for the various items of work,

unless it is ascertained that the franchise of the former owner is such as to require it to bear such costs, in which case it must be the responsibility of the Contractor to secure enforcement of said franchise if it so desires.

SECTION 8

PROSECUTIONS AND PROGRESS

8.1 SUBCONTRACTS

The Contractor may sublet the Contract work only in accordance with the provisions of these Specifications and with the consent of the City. The prime Contractor must be held responsible to see that its subcontractors and material suppliers conform to all the provisions of these Specifications. If the Contractor, after complying with these conditions, must sublet any portion of the proposed work to a Subcontractor, the Contractor under the original Contract must remain directly responsible to the City for all work being performed by it or by any Subcontractor under it, and all obligations imposed upon the Contractor in the original Contract must be equally binding upon any Subcontractor under it. The City will deal directly with and make all payment to the original Contractor. Contractor understands and acknowledges that the Subletting and Subcontracting Fair Practices Act (as set forth in the California Public Contracts Code) applies to the Contract and Contractor Agrees to comply with the terms of said Act.

8.2 ASSIGNMENT

The Contractor must not assign the Contract or sublet it as a whole without the written consent of the City. The Contractor must not assign or permit the assignment of or any lien on any money due or to become due to it hereunder without the proper consent of the City.

8.3 PROGRESS OF THE WORK

Time is of the essence in this Contract. Unless otherwise provided in the Special Provisions, the Contractor must begin work not later than 15 calendar days after the date of the Notice to Proceed, and the contractor must prosecute the work with due diligence so as to complete the work within the time specified in the Special Provisions or within such extension of time as may be granted.

Should the Contractor begin work in advance of receiving notice that the Contract has been approved as above provided, any work performed by it in advance of said date of approval must be considered as having been done by it at its own risk and as a volunteer, unless such Contract is so approved.

8.4 CHARACTER OF WORKMEN

The Contractor must employ none but skilled foremen and workmen upon work requiring special qualifications. When required by the Engineer, the contractor must discharge from the work and must not again employ without the consent of the Engineer any employee who is incompetent, disorderly, abusive, dangerous, insubordinate, or who in any way attempts to interfere with the employees of the City in the inspection and supervision of the work.

Any representative of the Contractor who is proven to have deliberately given false information about the performance of any part of the work must be discharged if so ordered by the City Engineer.

8.5 TEMPORARY SUSPENSION OF WORK

The City Engineer may order the Contractor to suspend work when, in his/her opinion, the conditions are such as to prevent the work being properly carried out. Such conditions may include: war, government regulations, labor disputes, strikes, fire, floods, adverse weather or elements, inability to obtain material, labor or equipment, required extra work, or other specific as may be further described in the Specifications. When delay is caused by such order, an extension of time

may be granted when the conditions, in the opinion of the City Engineer, are such as could not have reasonably been foreseen. It is agreed that under no circumstances must the Contractor be excused from performance or entitled to any extra compensation or reimbursement because of any such suspension.

8.6 TIME OF ESSENCE, LIQUIDATED DAMAGES, EXTENSION OF TIME BY CITY

Time is of the essence, and, in case all the work called for under the Contract in all parts and requirements is not finished or completed by the date set forth in the Special Provisions, it is agreed by the parties to the Contract that circumstances and conditions as reflected by records of the City are such that material damage will be sustained by the City, and that it is and will be impracticable and extremely difficult to ascertain and determine the actual damage which the City will sustain in the event of any by reason of such delay. It is, therefore, expressly agreed that the Contractor will pay to the City the sum stated in Special Provisions per day for each and every calendar days delay in finishing the work beyond the date prescribed; and the Contractor agrees to pay said liquidated damages as herein provided. In case the same are not paid, Contractor agrees that the City may deduct the amount thereof from any monies due or that may become due the Contractor under the Contract.

It is further agreed that in case the work called for under the Contract is not finished and completed in all parts and requirements by the date specified, the City must have the right to extend the time of completion or not, as may be deemed to best serve the interest of the City. If it is decided to increase said time, said City must further have the right to charge to the Contractor, its heirs, assigns or sureties and to deduct from the final payment for the work all or any part, as may be deemed proper, of the actual cost of engineering, inspection, superintendence, and other overhead expenses which are directly chargeable to the Contract and which accrue during the period of such extension, except that cost of final surveys and preparation of final estimate must not be included in such charges.

The time of completion will be extended and the Contractor must not be assessed with liquidated damages during any delay beyond the day named for completion of the work caused by Acts of God or acts of the public enemy, fires, floods, epidemics, quarantine restrictions, strikes, and freight embargoes or delay of subcontractors due to such causes, provided the Contractor must notify the Engineer in writing of such cause or causes of delay within ten (10) days from the beginning of any such delay and includes in each monthly pay request the number of days of such delay which occurred in said pay period. Subject to and until entry of a judgment of a court of competent jurisdiction holding contrary to the decision of the Engineer's ascertainment of the facts of existence of such a cause of delay, the extent of the delay and of what constitutes a reasonable extension of time of completion in consequence thereof must be final and conclusive. Failure to give notice of cause of such time delay and failure of inclusion of the Contractor's request for extension based thereon in the monthly pay request as hereinabove provided will be deemed a waiver of right to extension of time for such cause subject only to impossibility of compromise therewith by the Contractor.

It is agreed that under no circumstances must the Contractor be excused from performance or entitled to any extra compensation or reimbursement because of any delay occasioned by or in any way arising out of any Acts of God or acts of the public enemy, fires, floods, epidemics, quarantine restrictions, strikes, and freight embargoes or delay of subcontractors due to such causes.

8.7 DEFAULT BY CONTRACTOR

If the Contractor fails to begin delivery of material and equipment, to commence the work within the time specified, to maintain the rate of delivery of material, to execute the Work in the manner and at such locations as specified, or fails to maintain the work schedule which will insure the Agency's interest, or, if the Contractor is not carrying out the intent of the Contract, the Agency may serve written notice upon the Contractor and the Surety on its Performance Bond demanding satisfactory compliance with the Contract.

The Contract may be canceled by the City without liability for damage, when in the City's opinion the Contractor is not complying in good faith, has become insolvent, or has assigned or subcontracted any part of the work without the City's consent. In the event of such cancellation, the Contractor will be paid the actual amount due based on Contract unit prices or lump sums proposal and the quantity of the work completed at the time of cancellation, less damages caused to the City by acts of the Contractor. The Contractor, in having tendered a Proposal, must be deemed to have waived any and all claims for damages because of cancellation of Contract for any such reason. If the City declares the Contract canceled for any of the above reasons, written notice to that effect must be served upon the Surety. The Surety must, within 5 days, assume control and perform the work as successor to the Contractor.

If the Surety assumes any part of the work, it must take the Contractor's place in all respects for that part, and must be paid by the City for all work performed by it in accordance with the Contract. If the Surety assumes the entire Contract, all money due the Contractor at the time of its default must be payable to the Surety as the work progresses, subject to the terms of the Contract.

If the Surety does not assume control and perform the work within 5 days after receiving notice of cancellation, or fails to continue to comply, the City may exclude the Surety from the premises. The Agency may then take possession of all material and equipment and complete the work by City forces, by letting the unfinished work to another Contractor, or by a combination of such methods. In any event, the cost of completing the work must be charged against the Contractor and its Surety and may be deducted from any money due or becoming due from the Agency. If the sums due under the Contract are insufficient for completion, the Contractor or Surety must pay to the City within 5 days after the Notice of Completion resolution, all costs in excess of the sums due.

The provisions of this subsection must be in addition to all other rights and remedies available to the City under law.

8.8 WORK AT NIGHT – Not Applicable

8.9 MAXIMUM LENGTH OF OPEN TRENCH

Except by special permission of the Engineer, the maximum length of open trench where prefabricated pipe is used must not be greater than 500 feet, or the distance necessary to accommodate the amount of pipe installed in a single day, whichever is the greater. The distance is the collective length, including excavation, construction, pipe laying, backfilling, and compaction at any one location.

Except by special permission of the Engineer, the maximum length of open trench in any one location where concrete structures are poured in place will be that which is necessary to permit the uninterrupted progress of construction of the concrete structure, with construction pursued as

follows: excavation, setting of reinforcing steel, pouring of floor slab, walls, and cover slab or arch are to follow each other without any one of these operations preceding the next nearest operation by more than 200 feet.

Except by special permission of the Engineer, the maximum length of open trench in any one location where prefabricated concrete box conduit is used will be that which is necessary to permit the uninterrupted progress of construction of the concrete structure with construction pursued as follows: excavation, setting of reinforcing steel, pouring of floor slab, erection of side walls, erection of cover slab, and pouring of filler spaces are to follow each other without any one of these operations preceding the next nearest operation by more than 200 feet.

8.10 LIMITED ACCEPTANCE OF WORK

At any time during the progress of the work, the City may, upon written notice to the Contractor, take over and utilize the whole or part of the work, or appurtenance thereto which has been completed, giving, if desired, permits to utilize the same. Such use by the City must constitute a limited acceptance of that part of the work so taken over and utilized which must relieve the Contractor and its sureties from responsibility for any damage to, or defect in, that part of the work not inherent in its construction which may be caused by the use of such part by the City or by property owners under its permits.

SECTION 9

MEASUREMENT AND PAYMENT

9.1 MEASUREMENT FOR PAYMENT

Measurement and calculations of quantities for payment will be as hereinafter specified for the particular material to be furnished or class of work to be performed, unless otherwise specified in the Special Provisions.

It must be understood that the unit prices or lump sum amounts proposal must include full compensation for furnishing all labor, materials, tools, and equipment and doing all work shown on the Plans or stipulated in the Specifications for that particular item of work, unless otherwise specified in the Special Provisions.

When payment is specified to be made on the basis of weight, the weighing must be done on certified platform scales, and the Contractor must furnish the Engineer with the duplicate Certified Weighmaster's Certificates showing the actual net weights. When weighing is done on certified scales at a mixing plant, duplicate weight delivery tickets will be accepted. One ticket must be furnished to the inspector at the plant and one ticket to the Engineer at the site of work. The City will accept the certificates as evidence of the weight delivered.

9.2 SCOPE OF PAYMENT

The Contractor must accept the compensation as herein provided, in full payment for furnishing all materials, labor, tools, and equipment necessary to the completed work and for performing all work contemplated and embraced under the Contract; also for loss or damage arising from the nature of the work, or from the action of the elements, except as hereinbefore provided or from any unforeseen difficulties which may be encountered during the prosecution of the work until the acceptance by prosecution of the work; also for all expenses incurred in consequence of the suspension or discontinuance of the work as herein specified; and for completing the work according to the Plans and Specifications. Neither the payment of any estimate nor of any retained percentage must relieve the Contractor of any obligation to make good any defective work or material.

9.3 DEDUCTIONS FROM PAYMENTS

The City may, at its option and at any time, retain out of any amounts due the Contractor sums sufficient to cover any unpaid claims, provided that sworn statements of said claims must have been filed with the City.

9.4 SCHEDULE OF VALUES

Prior to the Contractor's application for the first progress payment, Contractor must submit a detailed breakdown of its bid by scheduled Work items and/or activities, including coordination responsibilities and project record document responsibilities. Where more than one subcontractor comprises the work of a work item or activity, the Schedule of Values must show a separate line item for each subcontract. Contractor must furnish such breakdown, of the total Contract Sum, by assigning dollar values (cost estimates) to each applicable Progress Schedule network activity, which cumulative sum equals the total Contract Sum. The format and detail of the breakdown must be as directed by City to facilitate and clarify future progress payments to Contractor for direct Work under Contract Documents. This breakdown must be referred to as the Schedule of Values.

Contractor's overhead, profit, insurance, cost of bonds and/or other financing, as well as "general conditions costs," (e.g., site cleanup and maintenance, temporary roads and access, off site access roads, temporary power and lighting, security and the like), must be prorated through all activities so that the sum of all the Schedule of Values line items equal Contractor's total Contract Sum.

City will review the breakdown in conjunction with the Progress Schedule to ensure that the dollar amounts of this Schedule of Values are, in fact, fair market cost allocations for the Work items listed. Upon favorable review by City, City will accept this Schedule of Values for use. City must be the sole judges of fair market cost allocations.

Any attempt to increase the cost of early activities, i.e., "front loading," will be rejected by City, resulting in a complete reallocation of monies until such "front loading" is corrected. Repeated attempts at "front loading" may result in suspension or termination of the Work or refusal to process progress payments, until such time as the Schedule of Values is acceptable to City.

9.5 PAYMENTS AND MONTHLY ESTIMATES

The City Engineer will, after the award of Contract, establish a monthly payment closure date. This date will be the date which will terminate each working month during the life of the Contract for which a monthly payment is payable. The Contractor will, within 5 days after the established monthly payment closure date of each month during the period in which work is being performed, make and deliver to the City two signed copies of monthly Contract payment applications stating the amount or percentage of work completed according to the Contract, as of the closure date established, estimated on the basis of the unit or lump sum Contract prices. No allowance will be made for materials and equipment not incorporated into the work. The City will independently verify the Contractor's monthly payment application and create a monthly progress payment request. The City's determinations for the amounts or percentages of work completed are final.

Except as otherwise provided in a labor compliance program applicable to the Work or as otherwise required by Owner, concurrently with each Application for Payment, Contractor shall submit to Owner Contractor's and its Subcontractors' certified payroll records required to be maintained pursuant to Labor Code Section 1776 for all labor performed during pay periods ending during the period covered by the Application for Payment

The City will prepare a warrant in an amount sufficient with all previous payments to make the aggregate 95 percent of the amount earned as certified, provided, however, that the City at any time after 50 percent of the work has been completed, if it finds that satisfactory progress is being made, may make any of the remaining partial payments in full, less authorized deductions.

The partial payments made as the work progresses will be payments on account and must in no way be considered as an acceptance of any part of the work or materials of the Contract, nor must they in any way govern the final estimate. Extra work will be paid for as specified in Section 4.3.3. Payments for unit price items will be made upon the basis of the unit prices proposal and the quantities of work done, calculated as hereinafter specified, for each particular item of work. However, where several types of work are included in a unit price item, the City will make partial payment for the portions of such work as are completed at the time of making the monthly estimates. All monies due the Contractor under the Contract will be paid on demand by the City, prepared and approved as required by law, and it is understood that any delay in the preparation, approval and payment of these demands will not constitute a breach of Contract on the part of the City.

Payments for lump sum items will be based upon the lump sum proposal and the City's estimate as

to the percentage of completion.

9.6 PAYMENT FOR EXTRA WORK

Payment for extra work will be made as provided by Section 4.3.3. Where payment is to be made on a force account basis, the Contractor and the City's representative must compare records of extra work performed by the Contractor on a force account basis at the end of each day. Copies of these records will be made in duplicate by the City's representative and must be signed by both the inspector and the Contractor's Representative, one copy being forwarded to the Contractor and one copy to the City. Bills for extra work must be signed by the Contractor and submitted to the City.

Each month the Contractor must include in the monthly payment application an estimate of the amount or cost of extra work performed as included in approved Contract Change Orders. The Contractor must submit, at the same time it returns the signed monthly payment application, a complete itemized statement of claim for all costs of extra work performed. Failure to include such a statement or claim for extra work for the pay period, or failure to deliver a complete statement for extra work in excess of that estimated by the City Engineer, must constitute a waiver on the part of the Contractor to any claim for payment for extra work not therein included.

9.6.1 Method of payment for extra work approved as specified in Section 4 under unit price or lump sum amounts or at stipulated prices must be the same as that for Contract items as set forth in this Section.

9.6.2 Payment for extra work by Contractor's force account must be made in the following manner:

Upon verification by the Engineer of the Contractor's statement for force account work, a claim will be prepared upon the proper claims form for approval of the City Engineer and presentation to the City Manager or Assistant City Manager, for his approval and direction.

9.7 FINAL PAYMENT

Upon completion of the Contract work, the City Engineer will, upon acceptance of the work by the City and 35 days after the date of recordation of the Notice of Completion, present the Contractor's claim for the balance of the total Contract price, less any sums which may lawfully be retained under the Contract.

Unless qualified by the Contractor under the procedure established in Section 9.5 hereof, the final progress payment request of the City Engineer must be taken as conclusive evidence of the amount of work done under the Contract. If the Contractor qualified its acceptance of the final progress payment and the parties fail to agree prior to the termination of the 35-day period after recordation of Notice of Completion, the final payment must not be delayed but must be made in accordance with the City Engineer's determination, subject to further claim of the Contractor and compliance by City with court order.

SECTION 10

CLAIMS BY CONTRACTOR

10.1 OBLIGATION TO FILE CLAIMS FOR DISPUTED WORK

10.1.1 Should it appear to Contractor that the Work to be performed or any of the matters relative to the Contract Documents are not satisfactorily detailed or explained therein, or should any questions arise as to the meaning or intent of the Contract Documents, or should any dispute arise regarding the true value of any work performed, work omitted, extra work that the Contractor may be required to perform, time extensions, payment to the Contractor during performance of this Contract, performance of the Contract, and/or compliance with Contract procedures, or should Contractor otherwise seek extra time or compensation FOR ANY REASON WHATSOEVER, then Contractor shall first follow all other procedures set forth in the Contract Documents and Standard Specifications. If a dispute remains, then Contractor shall give written notice to City that expressly invokes this Section 10. City shall decide the issue in writing within 15 days; and City's written decision shall be final and conclusive. If Contractor disagrees with City's decision, or if Contractor contends that City failed to provide a decision timely, then Contractor's SOLE AND EXCLUSIVE REMEDY is to promptly file a written claim setting forth Contractor's position as required herein.

10.1.2 Contractor shall present as its claims all Subcontractor, sub-Subcontractor and supplier claims of any type, and prove them under the terms of the Contract Documents. City shall not be directly liable to any Subcontractor, any supplier, or any other person or organization, or to any surety for or employee or agent of any of them, for damages or extra costs of any type arising out of or resulting from the Project.

10.2 FORM AND CONTENTS OF CLAIM

10.2.1 Contractor's written claim must be submitted via registered mail or certified mail with return receipt requested and must identify itself as a "Claim" under this Section 10 and must include the following: (i) a narrative of pertinent events; (ii) citation to contract provisions; (iii) theory of entitlement; (iv) complete pricing of all cost impacts; (v) a time impact analysis of all time delays that shows actual time impact on the critical path; (vi) reasonable documentation supporting items (i) through (v); and (vii) a verification under penalty of perjury of the claim's accuracy. The Claim shall be submitted to City within thirty (30) calendar days of receiving City's written decision, or the date Contractor contends such decision was due, shall be priced like a change order, and must be updated monthly as to cost and entitlement if a continuing claim. Routine contract materials, for example, correspondence, RFI, change order requests, or payment requests shall not constitute a Claim. Contractor shall bear all costs incurred in the preparation and submission of a Claim.

10.2.2 Upon receipt of a Claim, City shall conduct a reasonable review of the Claim. Within 45 days, or such expended period as City and Contractor may agree, City shall provide Contractor with a written statement identifying what portion of the claim is disputed and what portion is undisputed.

10.2.3 If City's governing body must approve City's response to the Claim and the governing body has not met within the 45-day (or extended) period, then City shall provide its written statement within three (3) days of the governing body's meeting.

10.2.4 City shall pay the undisputed portions of the Claim within 60 days of the issuance of a written statement identifying an undisputed portion.

10.2.5 Claims must be submitted on or before the day of final payment. Claims not submitted before final payment are deemed waived.

10.2.6 Notwithstanding and pending the resolution of any claim or dispute, Contractor shall diligently prosecute the disputed work to final completion in accordance with City's determination.

10.3 INFORMAL CONFERENCE AFTER CLAIM SUBMISSION

10.3.1 If the Contractor disputes City's response to its Claim, including a failure to respond, it may submit via registered mail or certified mail, return receipt requested, a written demand for an informal conference to meet and confer for settlement of the issues in dispute. City shall schedule such a meet and confer conference within 30 days for settlement of the dispute.

10.3.2 Within ten (10) days of the meet and confer conference City shall provide Contractor with a written statement identifying the portion of the Claim that remains in dispute and the portion that is undisputed.

10.3.3 City shall pay the undisputed portions of the Claim within 60 days of the issuance of a written statement identifying an undisputed portion.

10.4 MEDIATION

10.4.1 If the Contractor disputes City's statement provided under Paragraph 10.3(B) it shall inform City and the parties shall mutually agree to a mediator within 10 business days of the written statement. If the parties cannot agree upon a mediator, each party shall select a mediator and those mediators shall select a qualified neutral third party to mediate with regard to the disputed portion of the claim. Each party shall bear the fees and costs charged by its respective mediator in connection with the selection of the neutral mediator.

10.4.2 Mediation shall be confidential and non-binding. Unless otherwise agreed, by the parties or as provided in this Paragraph 10.4, the mediation shall be pursuant to the construction mediation procedures of JAMS and held at the JAMS office closest to the Project site.

10.4.3 The cost of mediation shall be equally shared by all parties to the mediation. The parties shall, prior to the commencement of mediation upon notice of the other party, exchange relevant, non-privileged project documents in compliance with Code of Civil Procedure Sections 2031.010, et seq. The parties may agree mutually to engage in additional discovery prior to mediation. Should the parties proceed with additional discovery, they shall, unless mutually agreed otherwise, comply with Code of Civil Procedure Sections 2019, et. seq. The mediator will undertake to resolve any discovery disputes relating to the mediation.

10.4.4 For Claims under \$375,000, unless the parties agree otherwise in writing, mediation pursuant to this Paragraph 10.4 shall excuse the mediation obligation under Public Contract Code Section 20104.4(a).

10.4.5 If mediation is unsuccessful, the parts of the Claim remaining in dispute shall be resolved as otherwise provided by the Contract and applicable law.

10.4.6 Following receipt of a Claim, the parties may mutually agree, in writing, to waive the mediation requirements of this Paragraph 10.4 and proceed to the commencement of a civil action.

10.4.7 All statutes of limitation shall be tolled from the date of the demand for mediation until a date two weeks following the mediation's conclusion.

10.5 OTHER MATTERS

10.5.1 The provisions of this Section 10 constitute a non-judicial claim settlement procedure that, pursuant to Government Code Section 930.2, shall constitute a condition precedent to submission of a valid Government Code Claim under the Government Code. Contractor shall bear all costs incurred in the preparation, submission and administration of a claim. Any claims presented in accordance with the Government Code must affirmatively indicate Contractor's prior compliance with the claims procedure herein and the previous dispositions under Paragraphs 10.3 and 10.4 above of the claims asserted. No suit may be brought against City arising out of or in connection with the Project unless and until Contractor presents to City a statutory Government Code Claim, in accordance with Government Code Sections 910, et seq. Pursuant to Government Code Section 930.2, the one-year period in Government Code Section 911.2 shall be reduced to 150 days from either accrual of the cause of action, substantial completion or termination of the contract, whichever occurs first; in all other respects, the Government Code shall apply unchanged.

10.5.2 Failure to submit and administer claims as required in Section 10 shall waive Contractor's right to claim on any specific issues not included in a timely submitted claim. Claim(s) or issue(s) not raised in a timely protest and timely claim submitted under this Section 10 may not be asserted in any subsequent litigation, Government Code Claim, or legal action.

10.5.3 Contractor shall submit Subcontractor claims in the same manner as other Claims. In the event a Subcontractor (on behalf of the Subcontractor or a lower-tier subcontractor) requests Contractor in writing to present a Claim to the City and furnishes reasonable documentation supporting the Claim, Contractor shall, within 45 days of receipt of the written request, notify the Subcontractor in writing as to whether the Contractor presented the claim to City and, if the Contractor did not present the Claim, provide the Subcontractor with a statement of the reasons for not doing so.

10.5.4 All waivers or modifications of this Section 10 may only be made a writing signed by City and Contractor, and approved as to form by legal counsel for both; oral or implied modifications shall be ineffective.

10.5.5 Any failure by City to respond within any time frame contained in Paragraphs 10.2 through 10.5 of this Section shall result in the Claim being deemed rejected in its entirety. No failure to meet a time requirement shall constitute an adverse finding with regards to the merits of the Claim or the responsibility or qualifications of the Contractor.

10.6 COMPLIANCE WITH STATUTORY PROCEDURES

10.6.1 The foregoing provisions of Paragraphs 10.2 through 10.5 are intended to comply with Public Contract Code Section 9204 and, to the extent applicable, Public Contract Code Section 20104, et seq. In the event of any conflict, the applicable Public Contract Code provision will

apply.

PART 4 – TECHNICAL SPECIFICATIONS

SECTION 12
TECHNICAL SPECIFICATIONS

12.1 MOBILIZATION

Mobilization shall include the obtaining of all permits; moving onto the site or to a storage yard near the site of all equipment and materials; and other construction facilities as required for the proper performance and completion of the work. Mobilization shall include demobilization as defined herein.

Mobilization shall include but not be limited to the following principal items:

- Preparation of Contract by the Contractor.
- Completion of all tasks and submittal of all documents (bonds, insurance, schedule, etc.) required as conditions of issuing the Notice to Proceed.
- Obtaining all required permits.
- Submitting and obtaining approval for all shop drawings and material submittals for signal equipment.
- Installing temporary construction water supply, power, wiring, and lighting facilities, as required at individual sites.
- Providing field office trailers if needed by the Contractor.
- Moving all Contractor's equipment required for operations onto the site.
- Having all OSHA required notices and establishment of safety programs.
- Attendance at Pre-Construction Conference of Contractor's principal construction personnel.
- Physical verification (potholing) of existing utilities. Potholing of existing utilities shall be performed to identify potential conflicts with the proposed improvements and existing; water lines, sanitary sewer, storm drain, dry utilities, gas, telephone, cable, electrical, and any other existing utility. If a pothole or bore hole is greater than eight (8) inches in diameter then the City Standard 215 "Standard Trench Detail Trench Backfill and Surfacing" shall apply. No additional compensation will be given to the contractor for the additional road restoration.

The contract lump sum price for "Mobilization" [Bid Item #100] shall include full compensation for furnishing all labor, materials, tools and equipment, and doing all work involved in mobilization and demobilization as listed above or required for the Contractor's operations. Full compensation for conforming to the requirements of this section shall be considered as included in the contract prices paid for under the "Mobilization" bid item. No additional compensation will be allowed.

12.2 WATER POLLUTION CONTROL PLAN

The project disturbs less than 1 acre, therefore a SWPPP is not required.

The following additional BMPs shall be implemented for street paving, repaving, reconstruction, patching or resurfacing.

1. Restrict paving and repaving activity to exclude periods of rainfall or predicted rainfall unless required by emergency conditions.
2. Install gravel bags and filter fabric or other appropriate inlet protection at all susceptible storm drain inlets and manholes to prevent contaminants from entering the storm drain.
3. Prevent the discharge of release agents including soybean oil, other oils, or diesel to the storm water drainage system or watercourses.
4. Minimize non-storm water runoff from water use for the roller and for evaporative cooling of the asphalt.
5. Clean equipment over absorbent pads, drip pans, plastic sheeting or other material to capture all spillage and dispose of properly
6. Collect liquid waste in a container, with a secure lid, for transport to a maintenance facility to be reused, recycled, or disposed of properly per 13-4.03D(5).
7. Collect solid waste by shoveling and vacuuming or sweeping and securing in an appropriate container for transport to a maintenance facility to be reused, recycled, or disposed of properly per 13-4.03D(5).
8. Cover “cold-mix” asphalt (i.e., pre-mixed aggregate and asphalt binder) with protective sheeting during a rainstorm per 13-4.03C(3).
9. Cover loads with tarp before haul-off to a storage site, ensuring that trucks are not overloaded.
10. Minimize airborne dust by using water spray during grinding per 14-9.03.
11. Avoid stockpiling soil, sand, sediment, asphalt material and asphalt grindings materials or rubble in or near storm water drainage system or watercourses per 13-4.03C(1),

The contract unit price paid for “Water Pollution Control Plan” [Bid Item #101] includes full compensation for furnishing all labor, materials, tools and equipment, and doing all work involved in water pollution control as listed above or required for the Contractor’s operations. Full compensation for conforming to the requirements of this section shall be considered as included in the lump sum price paid for “Water Pollution Control Plan” bid item. No additional compensation will be allowed.

12.3 CONSTRUCTION SURVEYING

Construction surveying including horizontal and vertical control and staking shall be the responsibility of the Contractor. Vertical and horizontal control is to be established from the existing Control Points shown on the Plans. Vertical Control Points are shown on the Plans.

Measurement and Payment

The Contractor shall consider complying with the provisions of this section as included in the prices paid for the various items of work and no additional compensation will be allowed therefor.

12.4 CONSTRUCTION STAKING

The approved plans provide sufficient information for a qualified surveyor to lay out the project. All working stakes shall be established by a licensed Land Surveyor or a registered Civil Engineer authorized to practice land surveying pursuant to Section 8725 of the Business and Professions Code of California. The Contractor shall be held responsible for the correctness of such working stakes. The Contractor shall furnish the Owner's Engineer legible notes seven (7) calendar days prior to the Contractor starting work in the area staked. The notes shall show the location of the working stakes in relation to the construction centerline or reference line, and all calculations used to reach the results of information written on the working stake marker. The location of the working stakes shall conform to the latest edition of the Caltrans Surveys Manual as shown in Chapter 12.

The Contractor shall provide a qualified "Grade Setter" to check horizontal and vertical alignment of all improvements in progress so that improvements will be built to conform to the lines, widths, and grades on the approved plans or any change order issued by the Engineer. The Contractor shall make available the "Grade Setter" to work with the Owner's Inspector on checking or verifying all grade stakes, blue tops, form work, etc., when requested by the Inspector. The "Grade Setter" shall provide all necessary equipment and tools to perform this work.

The Contractor is responsible for any and all re-staking expenses. The only exception is if there is found to be an error in the approved plans. All additional cost considerations will be included as part of any Change Order.

The Contractor shall preserve all existing benchmarks, survey control points, reference points, and other permanent points within the project limits. Unless noted in the plans, any survey control damaged by the Contractor shall be replaced by the Contractor's licensed Land Surveyor at no cost to the Engineer.

In addition to the survey work required for establishing "...the lines, widths, and grades on the approved plans (etc.)", the Contractor shall engage the services of a licensed land surveyor to fully comply with §8771(b) of the Land Surveyors' Act.

Measurement and Payment

The Contractor shall consider complying with the provisions of this section as included in the prices paid for the various items of work and no additional compensation will be allowed therefor.

12.5 PRESERVATION OF PROPERTY

The Contractor's attention is directed to Section 5-1.36 "Property and Facility Preservation" of the Standard Specifications. Building, fences, walls, and any other features which are not designated to be removed shall be protected in place. Any damage to these facilities shall be repaired by the Contractor entirely at their expense as directed by the Engineer.

Existing trees, shrubs, and other plants, that are not to be removed and are injured or damaged by reason of the Contractor's operations, shall be replaced by the Contractor at their cost. The minimum size of tree replacement shall be 24-inch box and the minimum size of shrub replacement shall be 15 gallons. Replacement ground cover plants shall be from flats and shall be planted 12 inches on center. The replacement specimen must be of the same species. All damaged vegetation is to be disposed of in a legal manner in accordance with local regulations.

Underground irrigation systems, outside of the public right-of-way, which are damaged or removed during construction, shall be restored within 48 hours of the first destruction or removal in order to be functional. The Contractor shall be responsible for all damage to existing vegetation to remain due to lack of irrigation from broken irrigation lines. The landscaping and any other facilities shall be replaced in kind or as approved by the Engineer.

Replacement of Damaged Surfaces

All concrete curbs, gutters, driveways, sidewalks or other surfaced areas which are broken or damaged shall be reconstructed by and at the expense of the Contractor, of the same kind of material and of the same dimensions as the original work, with the minimum requirement that concrete as specified herein shall be used. Repairs shall be made by removing and replacing the entire portion between joints or scores and not by refinishing the damaged part.

Appearance of Work

All work shall match the appearance of existing improvements to the satisfaction of the Engineer.

Utilities

The Contractor shall telephone Underground Service Alert (USA) at (800) 227-2600 or 811 a minimum of two working days prior to start of work so that underground facilities can be approximately located and marked on the surface by the various utilities.

The Contractor shall, prior to start of construction, excavate, probe, and determine the exact locations, both horizontally and vertically, of all utilities within the roadway. Any utilities that are in conflict with the proposed work shall be relocated by the respective utility companies. If any utilities are in conflict with the proposed work, the Contractor shall notify the Engineer in

writing of the location and elevation of the utility line that is in conflict. The Contractor shall coordinate all work with the utility companies under the direction of the Engineer.

The Contractor will be allowed additional working days equal to the number of working days that the relocation of utilities delays their work. No compensation will be allowed for idle time of equipment during the utility relocation.

Materials

Materials and quality of work shall conform to those specified by City Standards, the Standard Plans and Specifications, and these Specifications.

Restoration Due To Contractor's Means And Methods

The contract documents show the least impact to existing facilities for installation of the street improvements. As required by the shoring, dewatering, and/or pipe installation method as selected by the Contractor and approved by the Engineer, the Contractor shall restore existing curbs, gutters, sidewalks, and asphalt at no additional cost to the Engineer.

Measurement and Payment

The Engineer shall consider complying with the provisions of this section as included in the prices paid for the various items of work and no additional compensation will be allowed therefor.

12.6 CLEARING AND GRUBBING

Clearing and Grubbing shall conform to the provisions in Section 15, "Existing Facilities" and Section 17.2, "Clearing and Grubbing," of the Standard Specifications and these Specifications.

The construction area shall be stripped of all concrete, vegetable growth such as logs, stumps, roots, brush, grass, weeds, and other objectionable material as indicated on the Plans. Landscape improvements shall not be removed unless indicated as to be removed on the Plans. Existing vegetation outside the areas to be cleared and grubbed shall be protected from injury or damage resulting from the Contractor's operations. This work includes removal of asphalt berms, concrete, and miscellaneous items within the limit of work. All stripped organic material and items to be removed shall be disposed in accordance with local regulations.

Existing utility service lines are shown in approximate location on the contract plans. The Engineer assumes no responsibility for the accuracy or completeness of this information, which is offered solely for the convenience of the contractor. Contractor shall verify all horizontal and vertical locations of existing utilities and other obstructions prior to construction activities by potholing.

Nothing herein shall be construed as relieving the Contractor of the Contractor's responsibility for final cleanup of the roadway as provided in Section 4-1.13, "Cleaning Up," of the Standard Specifications.

Measurement and Payment

The contract unit price paid for "Clearing and Grubbing" [Bid Item #102] includes full compensation for furnishing all labor, materials, tools, equipment, and incidentals, and for doing all the work involved in clearing, grubbing and disposing the material, complete in place as specified in these Special Provisions, as shown on the Plans and as directed by the Engineer and no additional compensation will be allowed therefor.

12.7 REMOVE STRIPING

Traffic stripes and pavement markers shall be removed where noted on the plans by any method that does not materially damage the existing pavement. If grinding is used, grinding depth shall be limited to 0.05 feet. Residue resulting from removal operations shall be removed from pavement surfaces by sweeping or vacuuming before the residue is blown by the action of traffic or wind, migrates across lanes or shoulders, or enters drainage facilities.

All raised pavement markers shall be removed by the Contractor to the satisfaction of the Engineer and in accordance with Section 15 of the Standard Specifications.

Measurement and Payment

The contract unit price paid for "Remove Striping" [Bid Item #103] includes full compensation for furnishing all labor, materials, tools and equipment, and doing all work involved in removing thermoplastic pavement stripes and legends and raised pavement markers as listed above, required for the Contractor's operations, all as indicated on the plans, specified in the Standard Specifications, these special provisions, and as directed by the Engineer, and no additional compensation will be allowed.

12.8 REMOVE ASPHALT CONCRETE PAVEMENT

This work consists of removing and disposing existing asphalt concrete (AC) pavement on the site to full depth in the locations shown on the Plans, described in these special provisions, and directed by the Engineer.

The Engineer has not defined the thickness of asphalt. However, the Contractor shall assume the asphalt may be up to 9 inches thick.

The Contractor shall saw cut the pavement as required at all edges to be joined. Asphalt Concrete that has been removed shall be disposed of outside the project in a legal manner unless otherwise directed by the Engineer.

The Contractor shall assume pavement fabric is present in the existing section. The contractor is responsible for removing and disposing of pavement fabric and costs associated with disposal.

Measurement and Payment

The contract price per square foot for “Remove Asphalt Concrete” [Bid Item #104] shall include full compensation for furnishing all labor, materials, tools, equipment, and incidentals and for doing all work involved in the removal of existing Asphalt Concrete, including disposal, complete and in place, all as indicated on the plans, specified in the Standard Specifications, these special provisions, and as directed by the Engineer, and no additional compensation will be allowed.

12.9 REMOVE CONCRETE

This work shall consist of removal of existing sidewalk, ramps, curbs, gutters, and driveways as marked in the field and disposal of excess materials in accordance with the requirements specified in these specifications.

The Contractor shall protect from damage all existing improvements, drainage facilities, sanitary sewage facilities, water facilities, traffic signal facilities, landscaped areas, trees and shrubbery that are not required to be removed during construction. Any existing improvements, drainage facilities, sanitary sewage facilities, water facilities, traffic signal facilities, landscaped areas, etc., damaged as a result of the Contractor’s construction activities shall be replaced by the Contractor at no cost to the Owner.

The Contractor shall remove any through curb drains located in the concrete sidewalk. No separate payment will be made. Notify the engineer if these are removed.

When removing existing sidewalk, ramps, and driveways, the existing concrete shall be sawcut to a neat straight line at the limits of removal (score line for sidewalks) as marked in the field. Any damages to the adjoining improvements proposed to remain shall be repaired by the Contractor to the satisfaction of the Engineer at no cost to the Owner or adjacent Developers.

Measurement and Payment

The contract price per linear foot for “Remove Curb and Gutter” [Bid Item #105] shall include full compensation for furnishing all labor, materials, tools, equipment, and incidentals and for doing all work involved in the removal of existing curb and gutter, including saw-cutting, removal and stockpiling or disposal of the broken concrete material, excavation to the required subgrade depth, all as indicated on the plans, specified in the Standard Specifications, these special provisions, and as directed by the Engineer, and no additional compensation will be allowed.

The contract price per square foot for “Remove Concrete” [Bid Item #106] shall include full compensation for furnishing all labor, materials, tools, equipment, and incidentals and for

doing all work involved in the removal of existing sidewalk, driveways and ramps, including saw-cutting, removal and stockpiling or disposal of the broken concrete material, excavation to the required subgrade depth, all as indicated on the plans, specified in the Standard Specifications, these special provisions, and as directed by the Engineer, and no additional compensation will be allowed.

12.10 SAW CUT EXISTING PAVEMENT

The Contractor shall saw cut asphalt and concrete where required. Saw cutting shall be vertical and neatly edged and all the way through pavement to the sub grade. The sawing method shall consist of cutting a groove through the pavement with a power-driven concrete saw or equivalent. The Contractor shall provide a vacuum to remove water and debris during the saw cutting process.

Measurement and Payment

Full compensation for furnishing all labor, materials, equipment, and incidentals for doing all the work involved in the work contained in this section shall be considered as included in the prices paid for the various items of work and no additional compensation will be allowed therefor.

12.11 SCARIFICATION

This work shall consist of the scarification and re-compaction of native soil underneath the new hardscape as shown on the plans.

Upon excavation to subgrade depth in locations to receive new asphalt or concrete pavement, the soil shall be scarified to a minimum depth of 6 inches, moisture conditioned to within 2 to 5 percentage points above optimum moisture content, and compacted to a minimum relative compaction of 95 percent relative compaction to the maximum dry density as determined in the laboratory according to ASTM D1557.

The Contractor shall protect from damage all existing improvements, drainage facilities, sanitary sewage facilities, water facilities, traffic signal facilities, landscaped areas, trees and shrubbery that are not required to be removed during construction. Any existing improvements, drainage facilities, sanitary sewage facilities, water facilities, traffic signal facilities, landscaped areas, etc., damaged as a result of the Contractor's construction activities shall be replaced by the Contractor at no cost to the County.

It is the Contractor's responsibility to plan the preparation of the subgrade with respect to weather conditions. If poor weather creates excessive moisture in the subgrade or the inability to meet minimum compaction standards, the Contractor shall implement alternative methods as approved by the Engineer to continue subgrade preparation in accordance with these Plans and Specifications.

Measurement and Payment

Full compensation for furnishing all labor, materials, equipment, and incidentals for doing all the work involved in scarification shall be considered as included in the prices paid for the various items of work and no additional compensation will be allowed therefor.

12.12 EARTHWORK

This work shall be performed in accordance with Section 19, "Earthwork," of the Standard Specifications, these Specifications and as directed by the Engineer. After clearing and grubbing, removal of the existing asphalt pavement, and/or concrete in the locations shown in the Plans, the Contractor shall excavate aggregate base, native materials, or other substances of whatever nature to the required subgrade depth as shown on the Plans or as directed by the Engineer.

The Contractor shall complete earthwork including excavation, hauling, embankment, compaction, and fine grading of soil to establish the elevations as shown in the Plans. The following definitions apply to this section:

Borrow: Approved soil material for use as Structural Fill or Structural Backfill. This material shall have a Plasticity Index equal to 12 or less, be primarily granular and have less than 30% passing the #200 sieve.

Excavation: Removal of material encountered above subgrade elevations.

Authorized Over-Excavation: Excavation below subgrade elevations or beyond indicated horizontal dimensions as shown on Plans or authorized by the Engineer.

Unauthorized Over-Excavation: Excavation below subgrade elevations or beyond indicated horizontal dimensions without authorization by the Engineer. The Engineer will not pay for unauthorized excavation.

Subgrade: Surface or elevation remaining after completing excavation, or top surface of a fill or backfill immediately below subbase, base or topsoil materials.

Unsuitable Material: Any soil material that is not suitable for a specific use on the Project. The Engineer will determine if a soil material is unsuitable.

The Contractor shall:

- A. Protect open excavations with fences, covers and railings to maintain safe pedestrian and vehicular traffic passage.
- B. Prevent erosion of freshly graded areas during construction and until such time as permanent drainage and erosion control measures have been installed.
- C. Temporarily stockpile fill material in an orderly and safe manner and in a location approved by the Engineer.

- D. Provide dust and noise control in conformance to Section 12.2 WATER POLLUTION CONTROL PLAN of these Specifications.
- E. Do not enter environmental sensitive areas as directed by the Engineer. Protect these areas from soil or sediment resulting from grading operations.

Perform excavation, filling, compaction and related earthwork under the observation of the Engineer. Materials placed without approval of the Engineer will be presumed to be defective and, at the discretion of the Engineer, shall be removed and replaced at no cost to the Owner. Notify the Engineer at least 24-hours prior to commencement of earthwork and at least 48 hours prior to testing.

The Engineer will perform observations and tests required to enable him or her to form an opinion of the acceptability of the Project earthwork. The Contractor shall correct earthwork that, in the opinion of the Engineer, does not meet the requirements of these Technical Specifications.

Promptly notify the Engineer of surface or subsurface conditions differing from those disclosed in the Plans or the Technical Specifications. First notify the Engineer verbally to permit verification and extent of condition and then in writing. The Owner will not allow a claim for conditions differing from those anticipated in the Contract Documents unless the Contractor has notified the Engineer in writing of differing conditions prior to the Contractor starting work on affected items.

Excavation shall be accomplished with properly selected equipment, which has been approved by the Engineer and in such manner that the stability of the subgrade is maintained to the greatest extent possible and to prevent damage to underground utilities. The prepared subgrade shall not be permitted to dry and/or crack prior to placement of the next covering layer.

Measurement and Payment

Full compensation for conforming to the requirements of this Section shall be considered as included in the prices paid for the various contract items of work related to other roadway work and no separate payment will be made therefore.

12.13 AGGREGATE BASE

Aggregate bases shall conform to Section 26, "Aggregate Bases" of the Standard Specifications and these Specifications.

All aggregate base used for the project shall be Class 2. The grading shall be 3/4 inch maximum size aggregate. Aggregate base may include or consist of material processed from recycled asphalt concrete, Portland cement concrete, lean concrete base, cement treated base, or a combination of any of these materials.

The use of 100% recycled aggregate base is allowed with the following conditions:

- A. Shall conform to Section 26, "Aggregate Bases," of the Standard Specifications
- B. Use only within the roadway structural section
- C. 5% maximum asphalt concrete
- D. No glass
- E. No organic materials

The following defines the difference between recycled and reclaimed:

Recycled – developed through the recycling plant and is re-blended to conform with Section 26 requirements

Reclaimed – taken from one site, stockpiled, and re-used on another site and does not go through the plant and is not re-blended

The use of reclaimed asphalt is not allowed on this project. All reclaimed material must be re-processed through a crushing and screening plant.

If the Contractor intends to use recycled Class 2 aggregate base, they must provide independent laboratory testing illustrating that the proposed material conforms to the Class 2 material specification as defined in Section 26. The results must additionally include the data necessary to calibrate field compaction testing equipment to evaluate the material placed in reference with ASTM D1557. The Contractor shall supply testing results as necessary to the satisfaction of the Engineer.

In addition to R-value and durability index testing, the aggregate shall conform to the following additional quality requirement:

Test	Calif. Test Method No.	Requirement
Loss in Los Angeles Rattler (after 500 revolutions)	211	50% Maximum

Measurement and Payment

Full compensation for conforming to the requirements of this Section shall be considered as included in the prices paid for the various contract items of work related to other hardscape work and no separate payment will be made therefore.

12.14 HOT MIX ASPHALT

HMA shall be provided in accordance with the Standard HMA construction process and conform to Section 39 of the Standard Specifications. Aggregate shall be 1/2" HMA Type A for the asphalt concrete. Aggregate shall meet the quality requirements of Section 39 of the Standard Specification and have a maximum of 3% deleterious materials as determined by ASTM C142.

The Contractor shall furnish the Engineer, at least ten (10) working days prior to the start of work, a list of sources of materials together with a Certificate of Compliance signed by the material supplier or their representative indicating that materials to be incorporated in the work fulfill the requirements of these specifications, a job mix formula (JMF), a JMF verification, and the Contractor's Quality Control (QC) Plan per Section 39-2.01A(3)(b). The material certification must contain the lot number, and statements that the material is for this specific project and that the material complies with the specifications for the project. The JMF shall be performed in accordance with CTM 367. The proposed JMF shall be submitted using Form CEM-3511, Form CEM-3512 and Form CEM-3513, dated within 12 months of submittal. Form CEM-3513 shall be from Caltrans or a third-party laboratory certified by Caltrans. The Contractor shall be responsible for all costs associated with the required JMF, JMF verification, and the QC Plan. In addition to the Section 39-2.01A(3)(b) requirements, the Contractor QC Plan shall include the requirement of submittal of the previous days Caltrans Test 309 results and daily nuclear density test gage results per ASTM D2950 prior to commencing further paving. An example of the proposed test result forms shall be included in the Contractor QC Plan.

Asphalt concrete base shall be placed on the same day the area is excavated so that all areas will either have existing asphalt surface or new asphalt concrete base by the end of each working day. No subgrade areas shall be exposed or open to traffic during non-working hours. At the end of each working day the Contractor shall place reflectorized signs and delineators, as required for night-time use in accordance with the Standard Specifications, along all drop offs between the asphalt concrete base and the existing surfacing.

Liquid asphalt binder shall be PG 64-16 conforming to the latest published provisions in Section 92, "Asphalt Binders," of the Standard Specifications.

Liquid anti-stripping agent (LAS) shall be added to the asphalt binder at a rate of 0.5% by weight of asphalt binder. The LAS shall be AD-here LOF 65-00 or equivalent, and shall be stored, measured, and blended with the asphalt binder in accordance with anti-stripping agent manufacturer's recommended practice. The LAS can be added at the asphalt plant or at the refinery. When added at the asphalt plant, the equipment shall indicate and record the amount of LAS added. If added at the refinery, the shipping ticket from the refinery shall certify the type and amount of LAS added.

The Contractor shall use asphalt spreading machinery equipped with automatic screed controls and sensing devices that control the thickness, longitudinal grade and transverse screed slope. The Contractor shall also furnish a grade setter to ensure that the asphalt concrete base and asphalt concrete surface paving conforms to the lines and grades of the plans.

The entire extents of the top asphalt lift shall be completed in one final three (3) inch lift.

Measurement and Payment

The quantity of Asphalt Concrete Resurfacing shall be determined from certified weigh master tickets, relative to the amount of asphalt delivered, placed and compacted. The Engineer shall be supplied with a copy of each certified weigh ticket upon delivery for the Engineer's records. The quantities will be measured as follows:

“Hot Mix Asphalt” [Bid Item #107] shall be paid in a unit of weight in tons from certified weigh master tickets verified by the Engineer.

The contract unit price paid per ton for asphalt concrete includes full compensation for furnishing all labor, materials, tools, equipment, and incidentals, and for doing all work involved in removing, disposing, surface preparation, temporary pavement, furnishing and placing asphalt concrete as specified in the CSS, Plans, and these Specifications, and as directed by the Engineer.

Excess Asphalt Concrete will not be measured nor paid for.

12.15 PORTLAND CEMENT CONCRETE

The Contractor shall complete installation of Portland cement concrete curbs, gutters, sidewalks, and accessible curb ramps in the locations as shown on the Plans, as specified in these Special Provisions, and as directed by the Engineer. All work in this section shall be done in accordance with Section 73, “Concrete Curbs and Sidewalks” of the Caltrans Standard Specifications, except as modified in these Special Provisions. All concrete work shall be completed to the satisfaction of the Engineer prior to placement of hot mix asphalt.

Material

Prior to commencing work, the Contractor shall submit source and mix design for concrete conforming to the requirements of Section 73-1.02 of the Standard Specifications.

Execution

Curbs, gutters, sidewalks and curb ramps shall be constructed by the conventional use of forms.

The Contractor shall replace removed concrete with the final improvements within five (5) calendar days.

Layout of Improvements

The Contractor shall review field conditions and layout the improvements consistent with the applicable City of Rohnert Park, Sonoma County, and Caltrans standard plans. The Contractor shall furnish sufficient measuring equipment to verify that grades are compliant with accessible standards.

Subgrade and Base Preparation

After removal of the existing concrete, the Contractor shall excavate and prepare the subgrade as described in Section "Earthwork", of these Special Provisions. The Contractor shall place and compact class II aggregate base conforming to Section 26 of the Standard Specifications to 95% relative compaction conforming to ASTM D1557.

The subgrade shall be constructed and compacted true to line and grade, as required. All soft or unsuitable material shall be removed to a depth of not less than nine (9) inches below subgrade elevation and replaced with satisfactory material.

Forms

Forms conforming to the dimensions of the curb, gutter, sidewalk or driveway shall be carefully set to line and grade and shall be securely staked in place. The forms and subgrade shall be watered immediately in advance of placing concrete. Forms shall be thoroughly cleaned each time they are used and shall be coated with light oil or other releasing agent of a type that will not discolor the concrete. The Contractor shall request the Engineer complete an inspection of the forms two (2) days in advance of placing concrete. If the Engineer requires the Contractor to make correction, there shall be no additional cost to the Engineer.

Set fixed forms the full depth of the back and face of the curb. The back forms may be constructed with 1/2-inch-thick bender boards. Cleat the back forms together as required to attain the full depth of the curb. Use form clamps to prevent interference with finishing activities. Before removing the forms, finish the surface true to grade with a straightedge float at least 10 feet in length. Operate the straightedge float longitudinally over the concrete surface.

Remove the forms from the face of the curb from 1 to 6 hours after placing the concrete. Do not remove the forms if the concrete is plastic enough to slump.

Concrete Placement

The Contractor shall install formwork and receive approval from the Engineer prior to ordering concrete. The Contractor shall have sufficient personnel on site to manage the placement of the concrete.

Concrete shall be thoroughly spaded away from the forms to eliminate rock pockets next to the forms. The concrete may be compacted by mechanical vibrators acceptable to the Engineer. Tamping or vibrating shall continue until the mortar flushes to the surface and the coarse aggregate is below the concrete surface.

Expansion joints shall be spaced at 60-foot intervals, and deep scores at 5-foot intervals. Expansion joints shall be constructed vertical and at right angles to the centerline of the street. Joints shall be constructed at all radius points, driveways, and at adjoining structures.

Crack-control joints shall be constructed not more than ten (10) feet apart. Joints shall be made by the use of steel dividers, scoring or saw cutting to a depth of not less than one and one-half (1-1/2) inches and matching joints in adjacent sidewalks and/or driveways.

The concrete shall be cured by the section compound method. The curing compound shall be curing compound (6) as specified in Standard Specifications Sec. 90 1.03B, "Curing Concrete" of the Standard Specifications. The curing compound shall be applied in a manner that will provide a complete coating of all exposed faces of the concrete surface.

Finish

The surface shall be finished with appropriate finishing tools to match adjacent existing finish. The front-face form shall not be removed before the concrete has taken the initial set and has sufficient strength to carry its own weight. Gutter forms and rear forms shall not be removed until the concrete has hardened sufficiently to prevent damage to the edges. Any portion of the curb, gutter, sidewalk or driveway that is damaged shall be replaced by the Contractor.

The Contractor shall grade the adjacent areas to conform to the existing conditions. This may include placing topsoil. Topsoil shall be procured and imported from a local supplier.

The top and face of the finished curb must be true and straight. The top surface of the curb must be uniform in width and free from humps, sags, or other irregularities. Clean any discolored concrete by abrasive blast cleaning or other authorized method.

Except for curbs on structures, you may place curbs with an extrusion machine or a slip form paver if:

1. Finished curb is true to line and grade
2. Concrete contains the maximum quantity of water that maintains the curb's shape without support
3. Required surface texture is attained

Check the flatness of the top and face of the curb and the surface of the gutter with a 10-foot straightedge. The surfaces must be flat to within 0.01 foot except at grade changes or curves.

The Contractor shall restore private property improvements to existing or better condition.

Surface Restoration

The Contractor shall grade the adjacent areas to conform to the existing conditions. This may include placing fill. The Contractor shall restore private property improvements as described in "Existing Facilities" Section of these Special Provisions. For conform grading within the public right of way outside of the hardscape areas, the Contractor shall place mulch once grading is complete.

Sidewalk and Driveways

Sidewalk shall conform to the existing conditions and shall be set at grades conforming to accessibility requirements. All sidewalk and residential driveway replacement shall be completed in accordance with Sonoma County or Caltrans standard plans, as applicable.

Curb and Gutter

The Contractor shall establish positive drainage for repair of all curbs and gutters located adjacent to sidewalks and driveways.

Concrete curb and gutter adjacent to curb ramps and driveways are considered part of the bid item for concrete curb ramps and driveways.

Accessible Curb Ramps

The Contractor shall construct curb ramps as detailed in the 2018 Caltrans Standard Plans.

The Contractor shall place a cast in place detectable warning surface that must comply with section 12.16 Detectable Warning Surface.

Asphalt Plugs

The Contractor shall place asphalt plugs adjacent to new vertical curbs and gutters. The Contractor shall scarify and re-compact the subgrade as described in these Special Provisions and place hot mix asphalt as described in the “Hot Mix Asphalt” section, to a depth of at least nine (9) inches.

Conform Grading and Restoration

Installation of curb ramps and sidewalks may require conform grading as shown in the Plans. The Contractor shall cut and fill in accordance with Section “Earthwork” of these Special Provisions, restore planting, and irrigation to equal or better condition.

In conform areas adjacent to the sidewalk improvements, Contractor to hand broadcast a seed mix using native grasses to the City of Rohnert Park. The City pays for this work as part of the sidewalk item of work.

Measurement and Payment

Portland Cement Concrete shall be paid as follows:

The contract unit price for “Concrete Curb Ramp” [Bid Item #108], and “Concrete Sidewalk” [Bid Item #109] shall be paid per square foot and shall include full compensation for furnishing all labor, materials, tools, equipment and incidentals, and for doing all work involved in saw cutting, asphalt removal, earthwork, disposal of unsuitable materials, preparing the subgrade, furnishing and compacting the aggregate base, doweling into the existing concrete, furnishing and placing concrete, furnishing and placing curing compound, asphalt plugs, furnishing and

installing detectable warning surfaces, and landscape/hardscape replacement as shown as shown on the Plans and as directed by the Engineer and no additional compensation will be allowed therefor.

The contract prices paid per linear foot of “Concrete Curb and Gutter” [Bid Item #110] and “Concrete Vertical Curb” [Bid Item #111] includes full compensation for furnishing all labor, materials, tools, equipment and incidentals, and for doing all work involved in saw cutting, asphalt removal, earthwork, disposal of unsuitable materials, preparing the subgrade, furnishing and compacting the aggregate base, doweling into the existing concrete, furnishing and placing concrete, furnishing and placing curing compound, asphalt plugs, conform grading, and landscape/hardscape replacement as shown on the Plans and as directed by the Engineer and no additional compensation will be allowed therefor.

Full compensation for furnishing and installing dowels and epoxy required for the concrete construction shall be considered as included in the prices paid for the various contract items of work involved and no additional compensation will be allowed therefor.

Full compensation for applying curing compound to all exposed faces of the concrete surface shall be considered as included in the prices paid for the various contract items of work involved and no additional compensation will be allowed therefor.

Full compensation to procure, deliver, place, spread, and compact imported topsoil material shall be considered as included in the contract prices for the various contract items of work involved, and no additional compensation shall be allowed therefor.

12.16 DETECTABLE WARNING SURFACE

Detectable warning surface must be shown on the Authorized Material List for detectable warning surface and must comply with yellow color no. 33538 of FED-STD-595.

The Contractor shall guarantee in writing the warning surface for a period of five years (5) from date of completion. The guarantee includes defective work, breakage, deformation, and loosening of tiles

Measurement and Payment

Payment for this item shall be by the unit price for “Truncated Domes [Bid Item #113]”, which shall include full compensation for furnishing all labor, materials, tools and equipment, and doing all work involved in furnishing and installing Truncated Domes including anchoring in PCC, including but not limited to finish work. Full compensation for conforming to the requirements of this section shall be considered as included in the contract prices paid for under the “Truncated Domes” bid item. No additional compensation will be allowed.

12.17 NOT USED

12.18 NOT USED

12.19 NOT USED

12.20 NOT USED

12.21 NOT USED

12.22 TRAFFIC STRIPING, MARKINGS, AND RAISED PAVEMENT MARKERS

The Contractor shall furnish and apply traffic stripes, legends, markings, pavement markers, and other delineations and markings as noted in the project Plans. Contractor shall install or remove traffic striping and markers in accordance with Section 84 “Markings” of the Standard Specifications and the California Manual on Uniform Traffic Control Devices (MUTCD) latest edition.

All pavement legends and traffic striping shall be applied in thermoplastic unless otherwise noted. Placement shall be performed as directed by the manufacturer and at locations shown on the Plans.

Legends and arrows shall be pre-formed, thermoplastic pavement markings. Placement shall be performed as directed by the manufacturer and at locations shown on the Plans.

Raised non-reflective and retroreflective pavement markers shall comply with Section 81 “Miscellaneous Traffic Control Devices” of the Standard Specifications and be laid out according to the details in the Standard Plans. The specific type to be used shall be as shown on the plans or consistent with the type generally in use within the local jurisdiction, unless directed otherwise by the Engineer.

All construction shall conform to the respective provisions of the Standard Specifications, manufacturer’s installation requirements, and these construction details.

Layout for Temporary and Permanent Striping. The alignment and layout of traffic stripes shall conform to Section 84-2.03A, “General”, of the Standard Specifications.

The Contractor shall be responsible for accurately referencing out and replacing the lines and positions of all traffic lines, directional lines, arrows, and other markings in accordance with the Plans and City standard markings by cat tracking with painted marks. This shall occur no later than two hours behind the final surface course paving operation.

Cat tracking shall consist of stretching a rope on a straight line between control points on tangent alignment and on a true arc through control points on curved alignment and placing spots of paint along the rope. Temporary tab markers shall be placed not more than twelve (12') feet apart on curves nor more than twenty-four (24') feet apart on straight segments.

Prior to application of permanent striping and markers, the Contractor shall call for review and approval of the proposed striping by the Engineer. The City shall have the right to make changes in the location and alignment of line stripes. Striping and traffic markings shall not be applied until after approval is granted by the Engineer. The Contractor shall allow a minimum of three (3) working days for review of the layout by the City.

Raised pavement markers shall be placed as specified in Section 84-2.03, "Construction", of the Standard Specifications. When utilizing hot melt bituminous adhesive, pavement markers to be placed on new asphalt paving shall be placed after the surface has been open to traffic for at least seven (7) days. When utilizing epoxy adhesive, pavement markers shall be placed after the surface has been open to traffic for at least fourteen (14) days.

Permanent traffic striping and markings including legends and arrows to be placed on new asphalt paving shall be placed within twenty-one (21) days after paving or surfacing, unless otherwise directed by the Engineer.

Temporary white marking tape or floppies denoting new crosswalks shall be placed the same day that the existing crosswalk is removed.

Failure to comply with these requirements shall result in a liquidated damage of \$150 per day for the period of time when no north-south crosswalk is marked.

Pavement temperature shall be measured at the beginning of the shift on each working day and this information shall be provided to the Engineer.

No primer or thermoplastic shall be installed within forty-eight (48) hours from the last measurable rain report as provided by the City.

Thermoplastic traffic striping, legends, and arrows shall conform to the provisions of Section 84-1, "General"; Section 84-2.03B(2), "Thermoplastic", and refer to Section 81, "Miscellaneous Traffic Control Devices", and these Special Provisions.

Measurement & Payment

Payment for the white or yellow **Thermoplastic Striping** (4-inch, 6-inch, or 12-inch linear, per plan) shall be paid on a per linear foot basis, which shall include full compensation for furnishing all labor, materials, tools and equipment, and doing all work involved in layout and installation of striping or legends as listed above or required for the Contractor's operations. Full compensation for conforming to the requirements of this section shall be considered as

included in the contract prices paid for under the various unit prices for striping, legends. No additional compensation will be allowed.

Payment for the white or yellow **Thermoplastic Striping – CROSSWALK** shall be paid on a per square foot basis, which shall include full compensation for furnishing all labor, materials, tools and equipment, and doing all work involved in layout and installation of striping or legends as listed above or required for the Contractor’s operations. Full compensation for conforming to the requirements of this section shall be considered as included in the contract prices paid for under the various unit prices for striping, legends. No additional compensation will be allowed.

Payment for the **Thermoplastic Striping - YIELD LINES** (aka “shark teeth”) shall be paid on a per square foot basis, which shall include full compensation for furnishing all labor, materials, tools and equipment, and doing all work involved in layout and installation of striping or legends as listed above or required for the Contractor’s operations. Full compensation for conforming to the requirements of this section shall be considered as included in the contract prices paid for under the various unit prices for striping, legends. No additional compensation will be allowed.

Payment for red curb shall be paid on a per linear foot basis, which shall include full compensation for furnishing all labor, materials, tools and equipment, and doing all work involved in layout and installation of markings and paint as listed above or required for the Contractor’s operations. Full compensation for conforming to the requirements of this section shall be considered as included in the contract prices paid for under the various unit prices for striping, legends. No additional compensation will be allowed.

Payment for **Type A or AY Raised Markers** (white or yellow) shall be paid on a per each basis, which shall include full compensation for furnishing all labor, materials, tools and equipment, and doing all work involved in layout and installation of the markers as listed above or required for the Contractor’s operations. Full compensation for conforming to the requirements of this section shall be considered as included in the contract prices paid for under the various unit prices for striping, legends. No additional compensation will be allowed.

Payment for temporary markings or floppies shall be included in the prices paid for the various striping details or legends requiring temporary markings.

12.23 STRIPING REMOVAL

Traffic stripes and pavement markers shall be removed where noted on the plans by any method that does not materially damage the existing pavement. If grinding is used, grinding depth shall be limited to 0.05 feet. Residue resulting from removal operations shall be

removed from pavement surfaces by sweeping or vacuuming before the residue is blown by the action of traffic or wind, migrates across lanes or shoulders, or enters drainage facilities.

All raised pavement markers shall be removed by the Contractor to the satisfaction of the Engineer and in accordance with Section 15 of the Standard Specifications.

Measurement and Payment

Payment for “Remove Striping” [Bid Item #103] shall be on a lump sum basis , which shall include full compensation for furnishing all labor, materials, tools and equipment, and doing all work involved in removing thermoplastic pavement stripes and legends and raised pavement markers as listed above or required for the Contractor’s operations. No additional compensation will be allowed.

12.24 SIGNS

Signs and mounting brackets shall conform to section 82, “Signs and Markers” of the Caltrans Standard Specifications, the California Manual on Uniform Traffic Control Devices (most recent edition), and the Caltrans Sign Specification (most recent edition), and these Special Provisions.

Sign panels shall be aluminum and sign legends shall be retroreflective.

Signposts procurement and installations shall conform with City Standard Plan 705B.

Signs and equipment removed and salvaged from existing signage or RRFB assemblies shall be surrendered to the City for reuse. Contractor shall consult with City Engineer for drop-off location.

Measurement and Payment

Payment for “**Sign and Post**” [Bid Item #117] shall be on a by the unit price basis for each contract item involving Roadside Sign installation, which shall include full compensation for furnishing all labor, materials, tools and equipment, and doing all work involved in fabrication and installation of the specified roadside signs as required for the Contractor’s operations, including procurement of the sign panel, signpost, mounting equipment and accessories, and foundation materials. No additional compensation will be allowed.

Payment for **Sign and Post Removal** shall be on a lump sum basis for each location involving Roadside Sign removal, which shall include full compensation for furnishing all labor, materials, tools and equipment, and doing all work involved in the removal of the sign and post, including foundation, and restoration of the surrounding area, as required for the Contractor’s operations. No additional compensation will be allowed.

12.25 RECTANGULAR RAPID FLASHING BEACON (RRFB) ASSEMBLY

General

RRFB assembly shall include all equipment required for intended MUTCD-compliant functionality at each crossing location. RRFBs shall be solar-powered and communicate between flashing beacon wirelessly. The assembly shall include all signs, the rectangular rapid flashing beacon, Accessible Pedestrian Signal (APS) push buttons, solar engine (user interface, panel, and batteries), baseplates, poles/posts, all conductors and wiring, mounting brackets and other fasteners, and any other necessary equipment to achieve intended RRFB function. Contractor shall furnish and install all equipment as shown on project Plans.

RRFB assemblies furnished for this project shall all be from the same manufacturer regardless of mounting pole type.

Solar Engine - Mechanical

The solar engine shall be constructed from aluminum with an integrated solar panel. All batteries and electronics shall be mounted in the solar engine, with no external control cabinet or battery cabinet required.

The overall weight of the solar engine assembly (including two batteries but not including light bars or pushbutton) shall not exceed 20 lbs. (9.1 kg).

The solar engine shall be supplied with a fixed tilt angle of 45 degrees and shall be able to be oriented toward the equator with no additional mounting hardware.

Access to the interior of the solar engine shall have a lockable latch.

The solar engine shall be vented to provide cooling of the battery and electronic system. The vents shall be screened to prevent ingress by insects and debris.

Light Bar

The light bars shall be current-driven LED strings without active electronics. The LEDs shall be driven by pulse-width modulated fixed current.

The light bar housing shall be constructed from aluminum and shall have the approximate dimensions: 24" L x 1.5" D x 4.5" H (61.0 cm L x 3.8 cm D x 11.4 cm H).

Each light bar shall conform to all provisions of the MUTCD and FHWA requirements.

Each of the two modules in a light bar shall have 8 LEDs and shall be purpose-built by the manufacturer of the RRFB including the optics. The optics shall be premium, UV-resistant polycarbonate.

Each end of a light bar shall include a side-emitting pedestrian confirmation light composed of a single LED. Users shall have the option of using both confirmation lights for median applications, or covering one confirmation light with an included sticker for side-of-road applications.

The light bar shall be mounted to the post or pole using a separate bracket assembly to facilitate mounting two light bars back-to-back (bi-directional), if applicable per project Plans, and to allow the light bar(s) to rotate horizontally for aiming.

The light bar bracket shall be constructed from galvanized or stainless steel and shall have both banding and bolting mounting options and shall be able to be mounted to all specified pole types.

The light bar assembly shall open for access to the wiring connections for the LED modules. LED modules shall be rated to NEMA 3R.

Light bar wiring harnesses shall be included. All fasteners shall be stainless steel.

Mounting

Mountings of equipment shall conform to plans. Mounting adaptor for solar engine assembly shall be mountable to existing perforated square poles, existing luminaire poles, and/or new poles as specified in the project Plans. Contractor shall review each location to determine which adaptor or attachment will be necessary for deployment. Side mounts will only be allowed on existing street lighting poles.

Configuration

The solar engine shall house an auto-scrolling LED on-board user interface that provides on-site configuration adjustment, system status and fault notification.

The flash duration shall be adjustable in-the-field from 5 to 60 seconds in one second increments, 60 to 1,200 seconds in 60-second steps, and 3,600 seconds. Default flash duration shall be 20 seconds.

The flash rate shall be the wig-wag plus simultaneous (WW+S) providing 75 flashing sequences per minute. The flash rate of each individual RRFB indication, as applied over the full flashing sequence, shall not be between 5 and 30 flashes per second to avoid frequencies that might cause seizures.

The system shall provide configurable nighttime intensity settings ranging from 10% to 100% of daytime intensity.

The system shall be capable of enabling or disabling ambient brightness auto-adjustment. This feature allows the system to provide optimal output brightness in relation to ambient light levels while always maintaining adherence to SAE J595 Class I specifications. If enabled, the ambient brightness auto-adjustment shall adjust output to a range between 50% and 100% of daytime intensity.

Activation duration, night intensity setting and adjustment for ambient daytime brightness shall be automatically broadcast to all RRFBs in the system when changed in one RRFB at a single location/crossing.

Solar Panel System

The solar engine shall include one 18V nominal solar panel rated at 15 watts with bypass diode. Nominal voltage of the RRFB shall be 12 volts. The solar panel shall be no larger than the footprint of the solar engine enclosure.

Electrical connections on the back of the solar panel shall be contained with an enclosure that prevents accidental contact with either of the power leads.

The solar charging system shall use maximum power point tracking (MPPT).

Battery System

The solar engine shall house the required batteries without the need for an external enclosure.

The battery charging system shall be 3-stage and incorporate temperature-compensation to prevent battery overcharging in hot weather.

Batteries, in conjunction with recommended RRFB performance, shall be designed for a demonstrable service life of at a minimum **5 years**.

The operating temperature range of the battery shall be -40° to 140°F (-40° to 60°C).

Batteries shall have quick connections to facilitate installation and be readily available from multiple suppliers and non-proprietary.

Batteries shall be supported by rubber bumpers and be secured in place with straps.

Operational Specifications

The color of the yellow light bar indications shall meet the specifications of SAE standard J578 (Color Specification) dated December 2006.

The RRFB system shall have the capacity to meet a minimum array-to-load (ALR) of 1.2 while meeting the specified daily activations and flash duration year-round using the applicable peak sun hours insolation available at the installation location.

The controller shall be able to support up to 1.4 amps combined current through the RRFB fixtures simultaneously.

The system shall use a dedicated light sensor to detect night and day states and apply any optionally enabled intensity adjustments.

Radio System

The radio system shall operate at 2.4GHz.

Upon detection of a pushbutton press, an RRFB will broadcast an activation to all other nearby RRFBs sharing the same channel.

The RRFB shall have the capability to activate other RRFBs by wireless communications within 1,000 feet (304 meters).

The RRFB shall have a minimum of 10 unique channels that can be configured on-site to avoid inadvertent activation of nearby systems.

The antenna shall be a low-profile “button” shape that cannot be bent or broken by vandals.

Accessible Pedestrian Signal (APS) pushbutton

The system shall be capable of activation by pedestrian pushbutton. All RRFBs in the system shall initiate activation simultaneously within 150ms of activation. If an additional activation occurs while the system is activated, the flash duration shall reset. For example, with the flash duration set to 20 seconds, if an additional activation occurs after the RRFB has been activated for 15 seconds the RRFB will continue for an additional 20 seconds, or 35 seconds in total. If the RRFB has ceased its flashing cycle, any subsequent activation shall activate the RRFB immediately regardless of how recently the RRFB ceased operation.

Pedestrian push buttons within the RRFB assembly shall be the Accessible Pedestrian Signal, Bulldog type and shall be compatible with the City’s existing equipment and vendor(s). Buttons shall emit an audible sound when not in use and the sound level shall be variable depending on ambient noise levels.

Environmental

The RRFB solar engine and light bars shall be rated to a minimum of NEMA 3R.

Poles/Posts

All poles and posts furnished for the RRFB assembly shall comply with Caltrans Standard Plans (2022, or most recent version) and/or the City of Rohnert Park sign standards, as noted on the Plans. Contractor shall submit products for Engineer approval prior to purchase for each location.

Measurement and Payment

The contract unit price for “Double-Sided RRFB Assembly” [Bid Item #116] shall be paid on per each basis for each assembly and shall include full compensation for furnishing all labor, materials, tools, equipment and incidentals, and for doing all work involved in installation as shown on the Plans and as directed by the Engineer and no additional compensation will be allowed therefor.

PART 5 – DRAWINGS

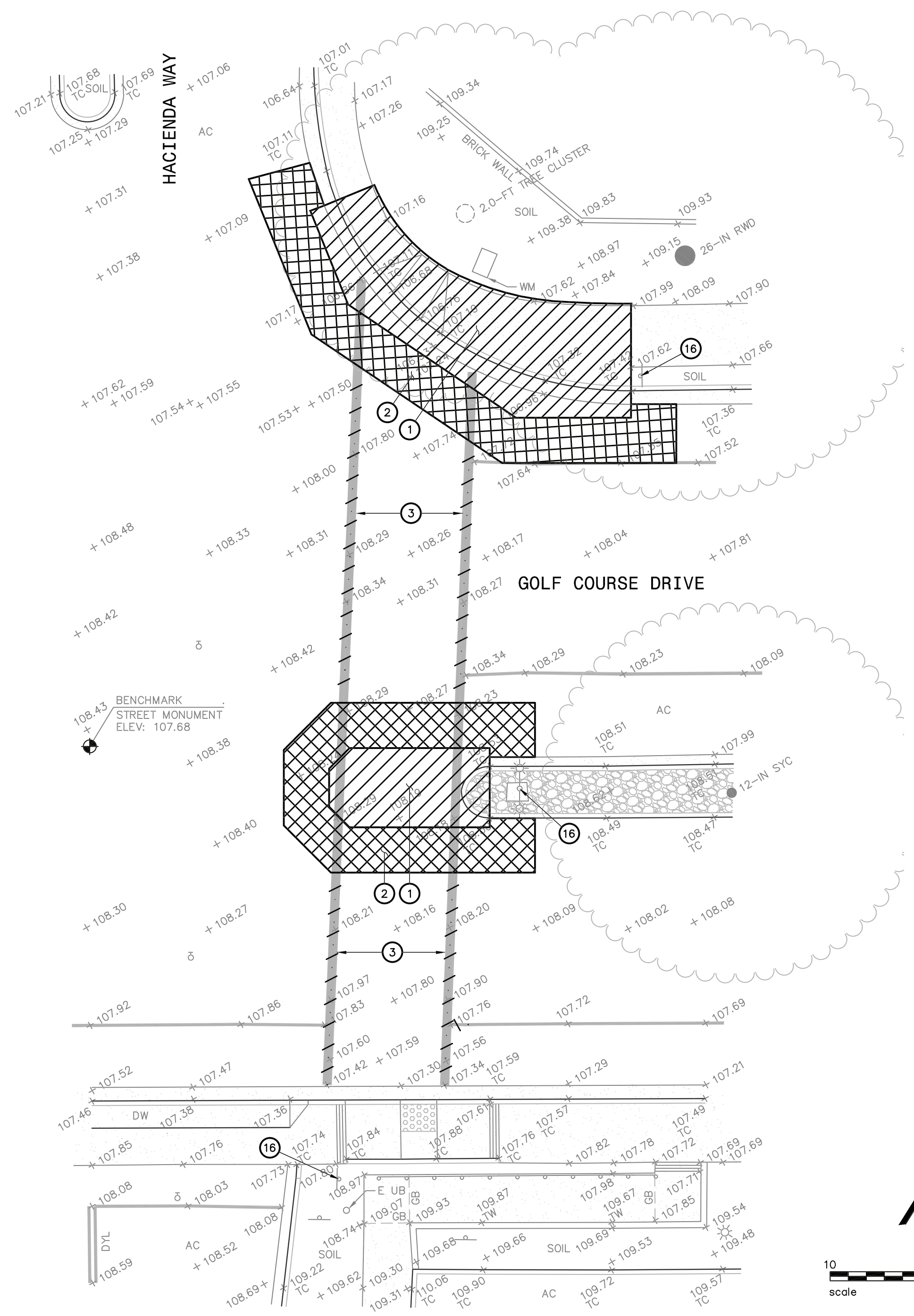

- KEYNOTES**
- ① SAWCUT WHERE REQUIRED AND REMOVE EXISTING MATERIAL TO FACILITATE THE PROPOSED IMPROVEMENTS AND DISPOSE OF MATERIAL IN ACCORDANCE WITH LOCAL REGULATIONS.
 - ② EDGE GRIND EXISTING ASPHALT CONCRETE A MINIMUM OF 5-FEET IN ACCORDANCE WITH THE CITY OF ROHNERT PARK STANDARD 208 AS REQUIRED TO PROVIDE AN ASPHALT OVERLAY HAVING A MINIMUM DEPTH OF 1-1/2-INCH, WHICH UNIFORMLY CONFORMS TO THE EXISTING SURFACE ELEVATION AND DOES NOT IMPEDE DRAINAGE.
 - ③ SANDBLAST OR GRIND TO PERMANENTLY REMOVE EXISTING STRIPING AS REQUIRED TO FACILITATE PROPOSED IMPROVEMENTS.
 - ⑯ REMOVE SIGN. FOR ADDITIONAL INFORMATION SEE SIGNAGE AND STRIPING DRAWINGS.

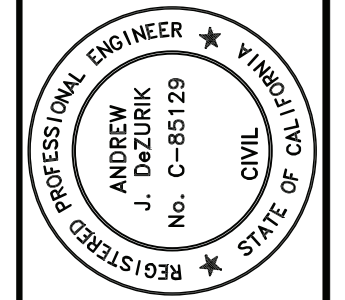

11/15/2023
 ANDREW J. DEZURIK
 C 85129

BKF ENGINEERS
 200 4TH STREET
 SUITE 300
 ROHNERT PARK, CA 95017
 (707) 583-8500
 www.bkf.com

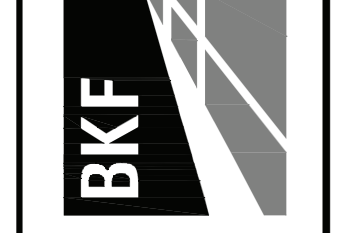

**PEDESTRIAN RAMP IMPROVEMENTS
 GOLF COURSE DRIVE AT HACIENDA WAY
 ROHNERT PARK, CALIFORNIA
 DEMOLITION PLAN**

Revisions	No.	Date	By	Appr.

APPROVED FOR CONSTRUCTION:

 VANESSA MARIN GARRETT, R.C.E. 84141
 CITY ENGINEER, CITY OF ROHNERT PARK
 LICENSE EXPIRES SEPTEMBER 30, 2025
 DATE: 11/29/2023

Plot Nov 15, 2023 at 2:11pm
 212283 MPP.dwg
 COPYRIGHT © 2021 BKF ENGINEERS

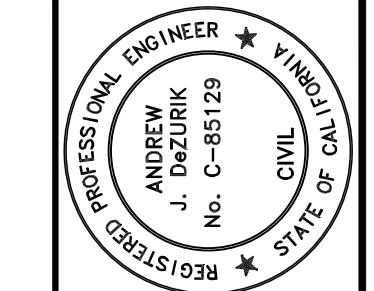

11/15/2023
 ANDREW J. DEZURIK
 C 85129

BKF ENGINEERS
 200 4th STREET
 SUITE 300
 SAN JOSE, CA 95101
 (707) 583-8500
 www.bkf.com

**PEDESTRIAN RAMP IMPROVEMENTS
 GOLF COURSE DRIVE AT HALCYON PLACE
 ROHNERT PARK, CALIFORNIA**

Revisions	
No.	Description

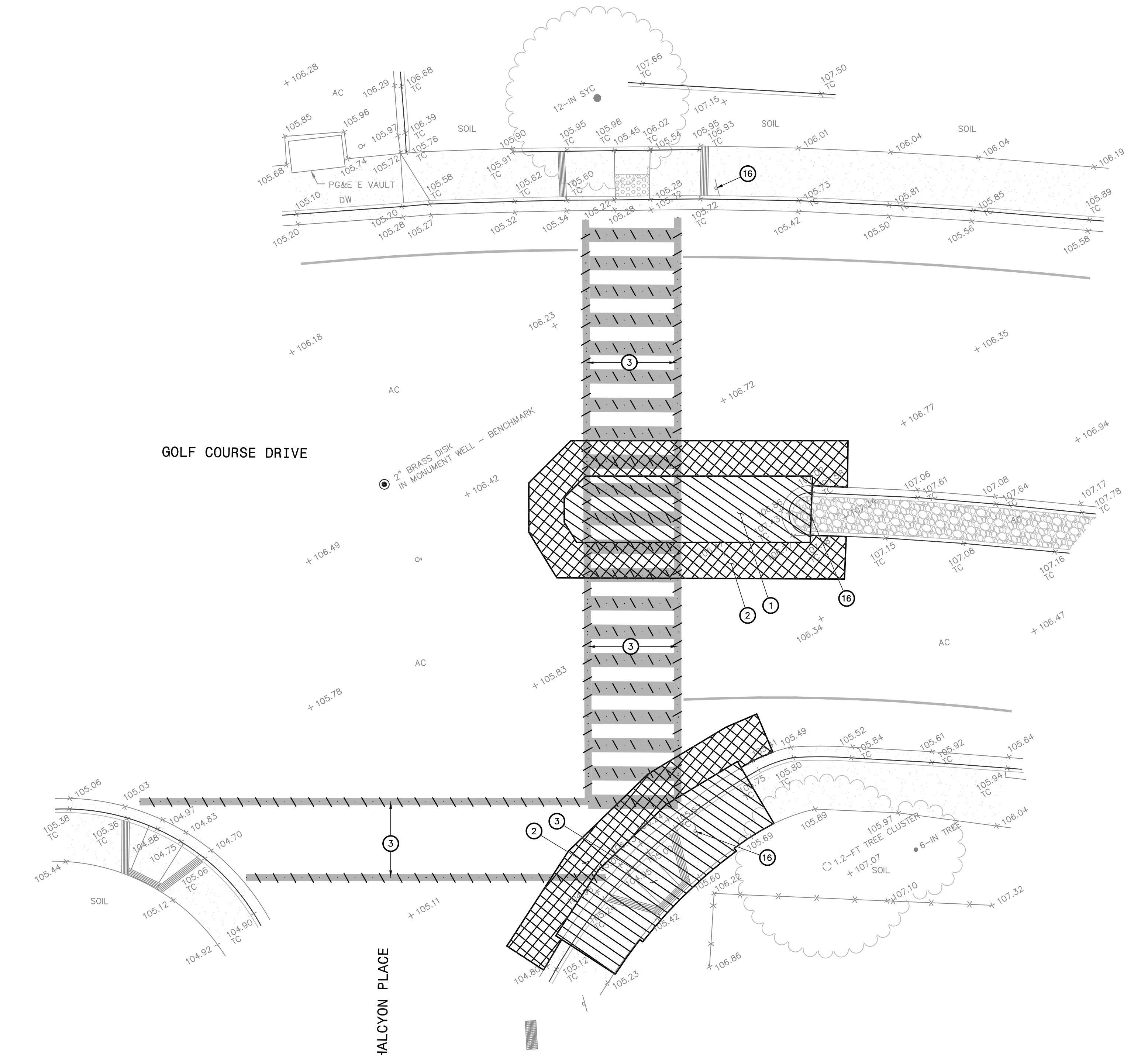

- KEYNOTES**
- SAWCUT WHERE REQUIRED AND REMOVE EXISTING MATERIAL TO FACILITATE THE PROPOSED IMPROVEMENTS AND DISPOSE OF MATERIAL IN ACCORDANCE WITH LOCAL REGULATIONS.
 - EDGE GRIND EXISTING ASPHALT CONCRETE A MINIMUM OF 5-FEET IN ACCORDANCE WITH THE CITY OF ROHNERT PARK STANDARD 208 AS REQUIRED TO PROVIDE AN ASPHALT OVERLAY HAVING A MINIMUM DEPTH OF 1-1/2-INCH, WHICH UNIFORMLY CONFORMS TO THE EXISTING SURFACE ELEVATION AND DOES NOT IMPEDE DRAINAGE.
 - SANDBLAST OR GRIND TO PERMANENTLY REMOVE EXISTING STRIPING AS REQUIRED TO FACILITATE PROPOSED IMPROVEMENTS.
 - REMOVE SIGN. FOR ADDITIONAL INFORMATION SEE SIGNAGE AND STRIPING DRAWINGS.

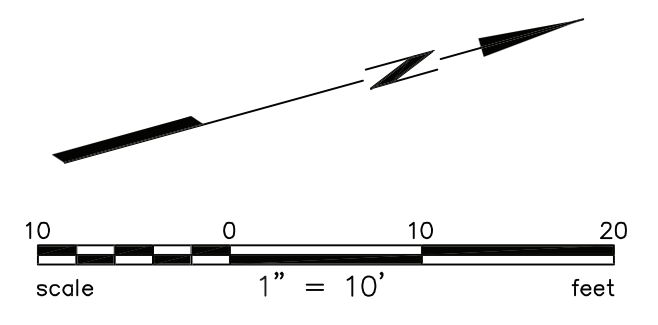

APPROVED FOR CONSTRUCTION:
Vanessa Marin Garrett 11/29/2023
 VANESSA MARIN GARRETT, R.C.E. 84141 DATE
 CITY ENGINEER, CITY OF ROHNERT PARK
 LICENSE EXPIRES SEPTEMBER 30, 2025

Plot No: 15_2023.dwg
 2/12/2023 10:00 AM
 COPYRIGHT © 2021 BKF ENGINEERS

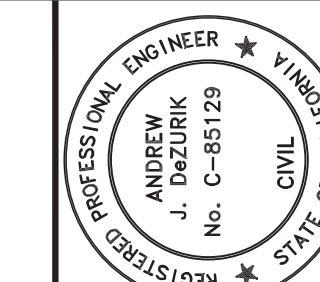

11/15/2023
ANDREW J. DEZURIK
C 85129

BKF ENGINEERS
200 4TH STREET
SUITE 300
ROHNERT PARK, CA 95001
(707) 583-8500
WWW.BKF.COM

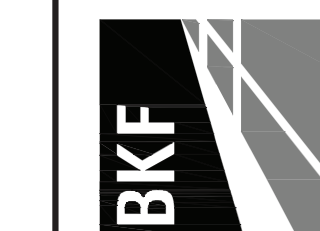

PEDESTRIAN RAMP IMPROVEMENTS
GOLF COURSE DRIVE AT HACIENDA WAY
ROHNERT PARK, CALIFORNIA

IMPROVEMENT PLAN

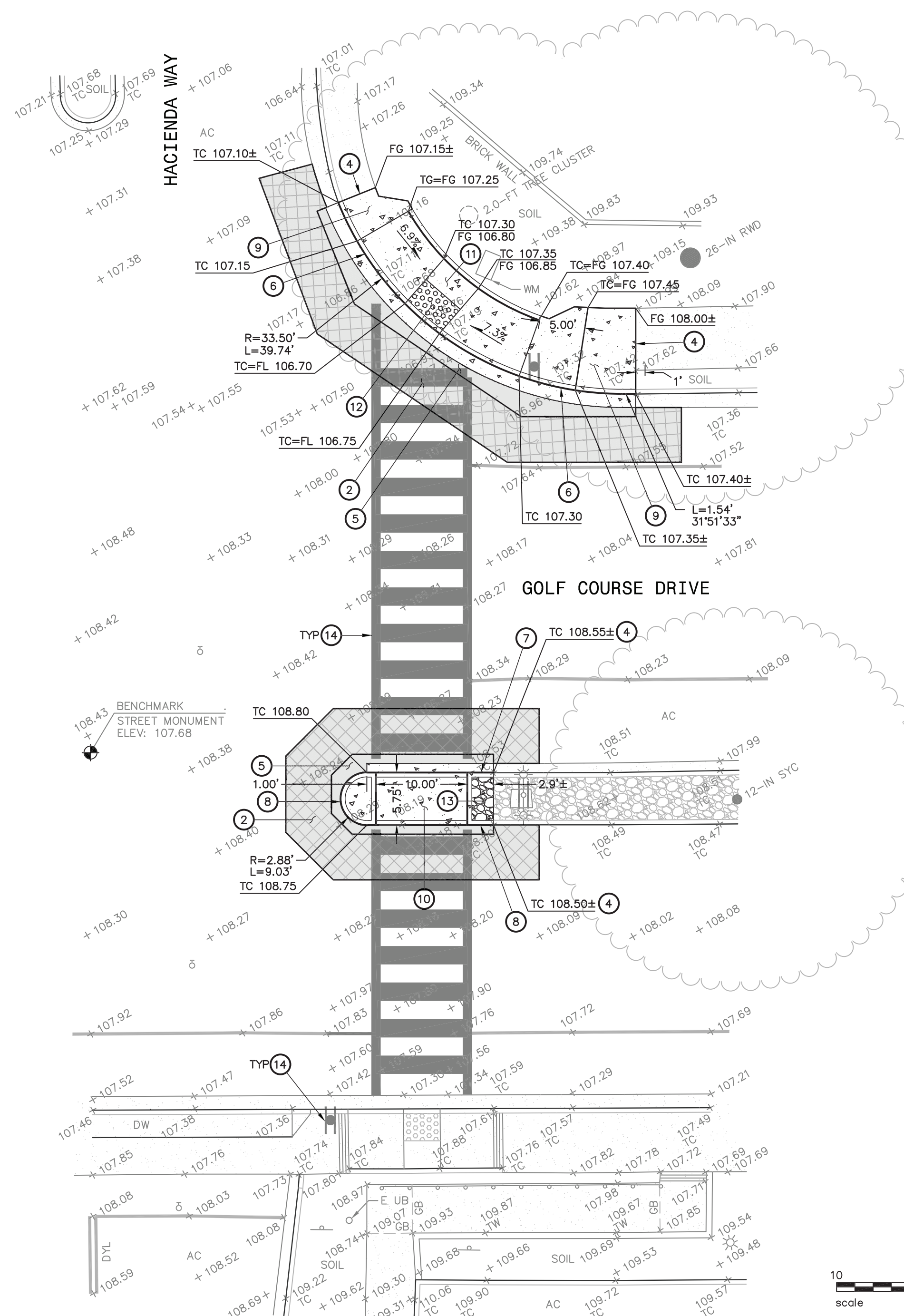

KEYNOTES

- ② EDGE GRIND EXISTING ASPHALT CONCRETE A MINIMUM OF 5- FEET IN ACCORDANCE WITH THE CITY OF ROHNERT PARK STANDARD 208 AS REQUIRED TO PROVIDE AN ASPHALT OVERLAY HAVING A MINIMUM DEPTH OF 1-1/2-INCH, WHICH UNIFORMLY CONFORMS TO THE EXISTING SURFACE ELEVATION AND DOES NOT IMPEDE DRAINAGE.
- ④ CONFORM TO EXISTING SURFACE ELEVATION IN A MANNER WHICH PROVIDES A UNIFORM TRANSITION BETWEEN SURFACES AND DOES NOT IMPEDE DRAINAGE.
- ⑤ NEW ASPHALT CONCRETE SECTION TO MATCH EXISTING, OR FULL DEPTH ASPHALT CONCRETE PLUG. SEE DETAIL 1 ON SHEET 6.
- ⑥ MODIFIED CURB AND GUTTER IN ACCORDANCE WITH CITY OF ROHNERT PARK STANDARD DETAIL 235 AND 241, HAVING A 18-INCH WIDE GUTTER PAN TO MATCH EXISTING.
- ⑦ STREET MEDIAN CURB AND GUTTER IN ACCORDANCE WITH CITY OF ROHNERT PARK STANDARD DETAIL 235, AND 242 TYPE B, HAVING A 12-INCH WIDE GUTTER PAN TO MATCH EXISTING.
- ⑧ STREET MEDIAN CURB IN ACCORDANCE WITH CITY OF ROHNERT PARK STANDARD DETAIL 235, AND 242 TYPE A.
- ⑨ NEW SIDEWALK IN ACCORDANCE WITH CITY OF ROHNERT PARK STANDARD DETAIL 230-A, 233, 235 AND 237.
- ⑩ NEW SIDEWALK IN ACCORDANCE WITH CITY OF ROHNERT PARK STANDARD DETAIL 235 AND 237, 2% MAX IN ANY DIRECTION.
- ⑪ MODIFIED CASE C CURB RAMP IN ACCORDANCE WITH CALTRANS STANDARD PLAN AB8A. PAVEMENT SECTION TO BE 6-INCHES CONCRETE OVER 6-INCHES AGGREGATE BASE.
- ⑫ DETECTABLE WARNING SURFACE IN ACCORDANCE WITH SECTION 11B-705.1.1 OF THE 2019 CALIFORNIA BUILDING CODE.
- ⑬ REPLACE EXISTING ROCK TO MATCH EXISTING AFTER THE PROPOSED IMPROVEMENTS HAVE BEEN COMPLETED.
- ⑭ SIGNAGE AND STRIPING SHOWN FOR REFERENCE ONLY. FOR ADDITIONAL INFORMATION SEE SIGNAGE AND STRIPING DRAWINGS.

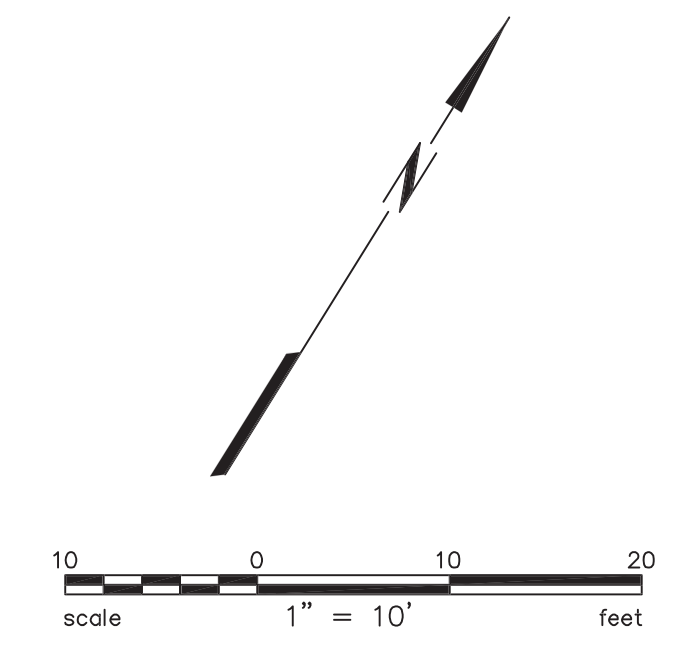

Rev Nov 15, 2023 at 2:10pm

APPROVED FOR CONSTRUCTION:
Vanessa Marin Garrett 11/29/2023
 VANESSA MARIN GARRETT, R.C.E. 84141 DATE
 CITY ENGINEER, CITY OF ROHNERT PARK
 LICENSE EXPIRES SEPTEMBER 30, 2025

Revisions	No.	Date	Scale	Design	Drawn	Approved	App. No.

Drawing Number:

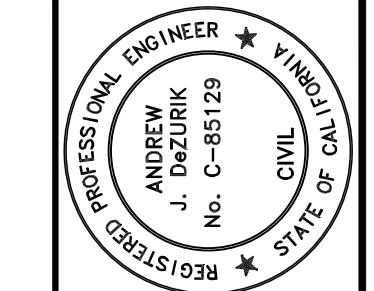

11/15/2023
 ANDREW J. DEZURIK
 C 85129

BKF ENGINEERS
 200 4th STREET
 SUITE 300, OAKLAND, CA 94612
 (707) 583-8500
 www.bkf.com

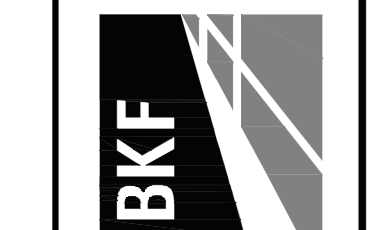

PEDESTRIAN RAMP IMPROVEMENTS
 GOLF COURSE DRIVE AT HACIENDA WAY AND HALCYON PLACE
 ROHNERT PARK, CALIFORNIA
CONSTRUCTION DETAILS

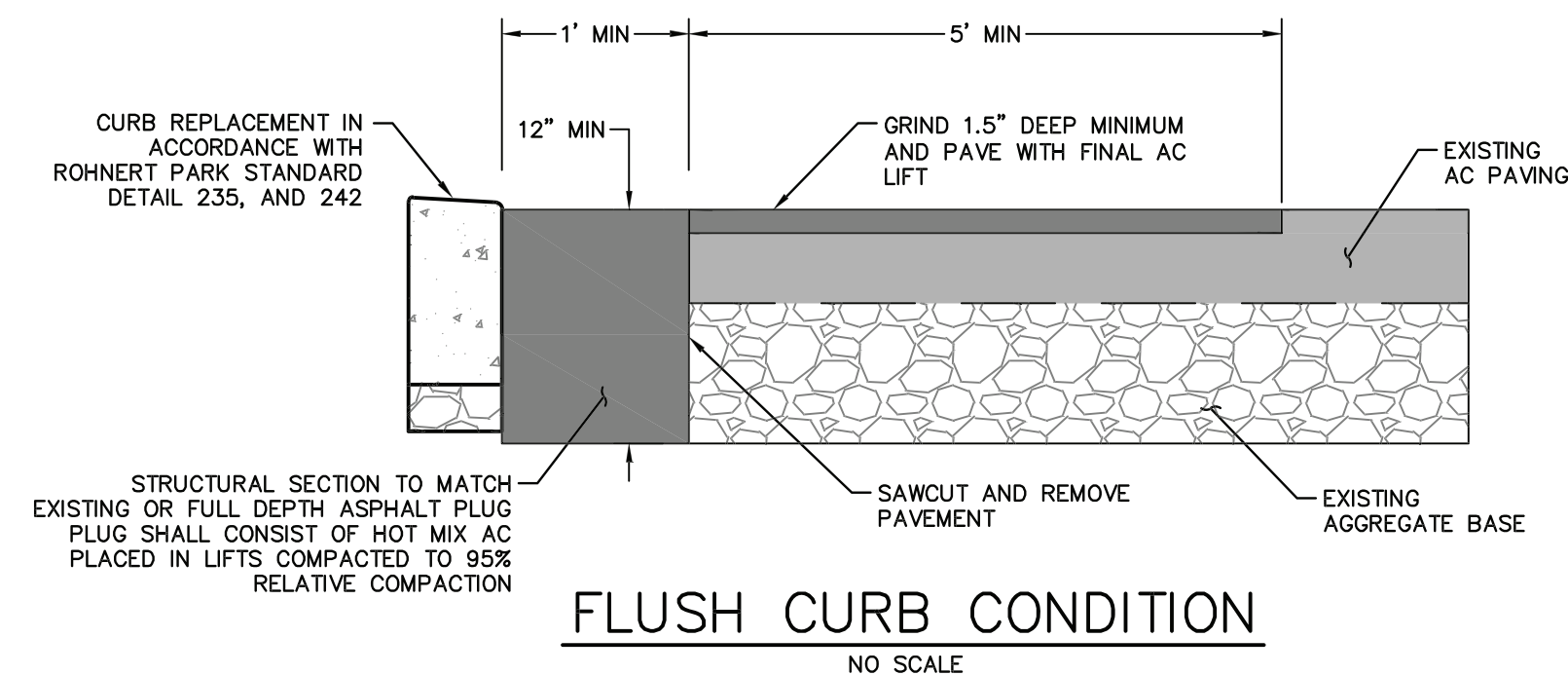
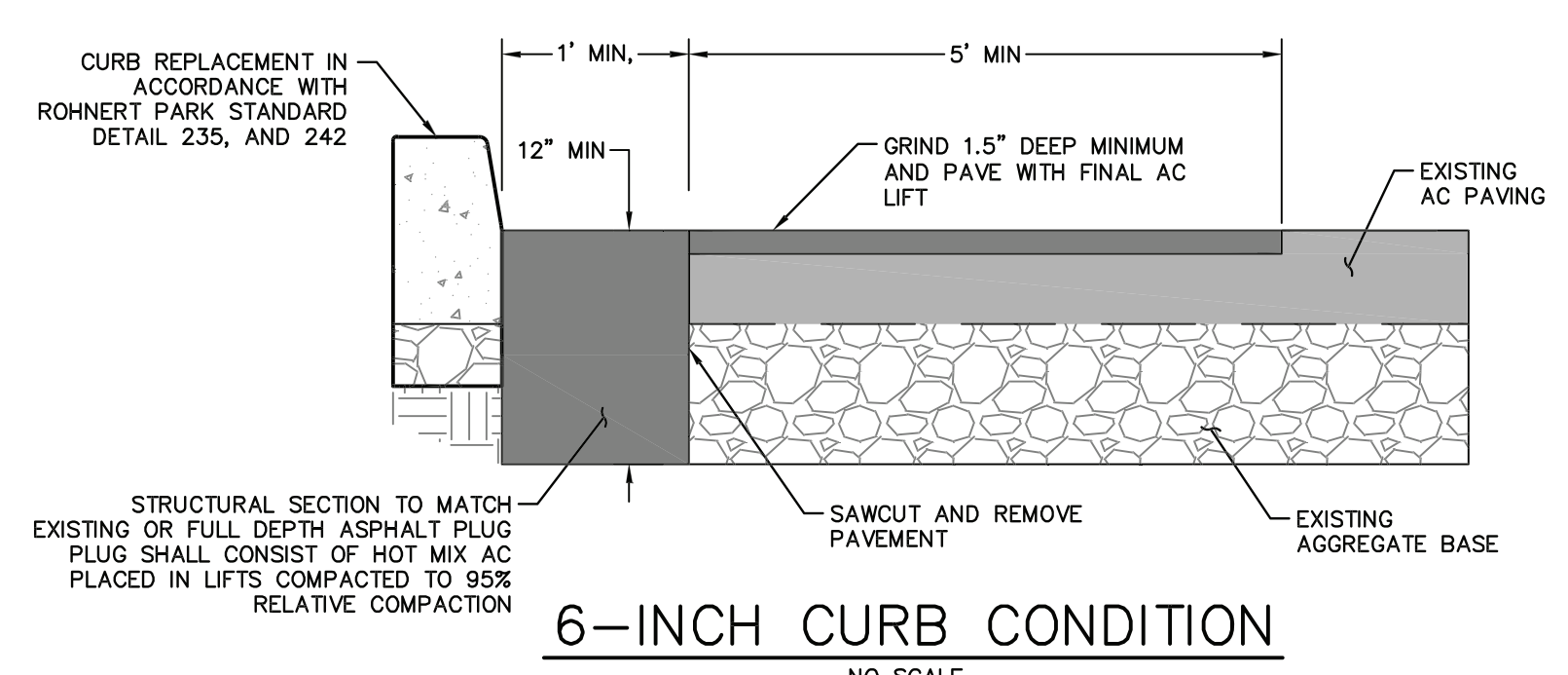

- NOTES:**
- ALL SOFT OR SPONGY SUB-GRADE MATERIAL SHALL BE REMOVED AND REPLACED WITH SUITABLE MATERIAL AS REQUIRED BY THE ENGINEER.
 - A TACK COAT, TYPE SS-1 SHALL BE APPLIED TO ALL MATING SURFACES ALONG THE LIP OF GUTTER AND AT CONFORMS TO EXISTING PAVEMENT PRIOR TO PLACING NEW HOT MIX ASPHALT CONCRETE PAVEMENT. THE TACK COAT SHALL CONFORM TO SECTION 94, "ASPHALTIC EMULSIONS" OF THE CALTRANS STANDARD SPECIFICATIONS.
 - FINAL AC CONFORM SURFACE SLOPES SHALL BE IN ACCORDANCE WITH GRADES ON PLAN AND NO GREATER THAN 5%.

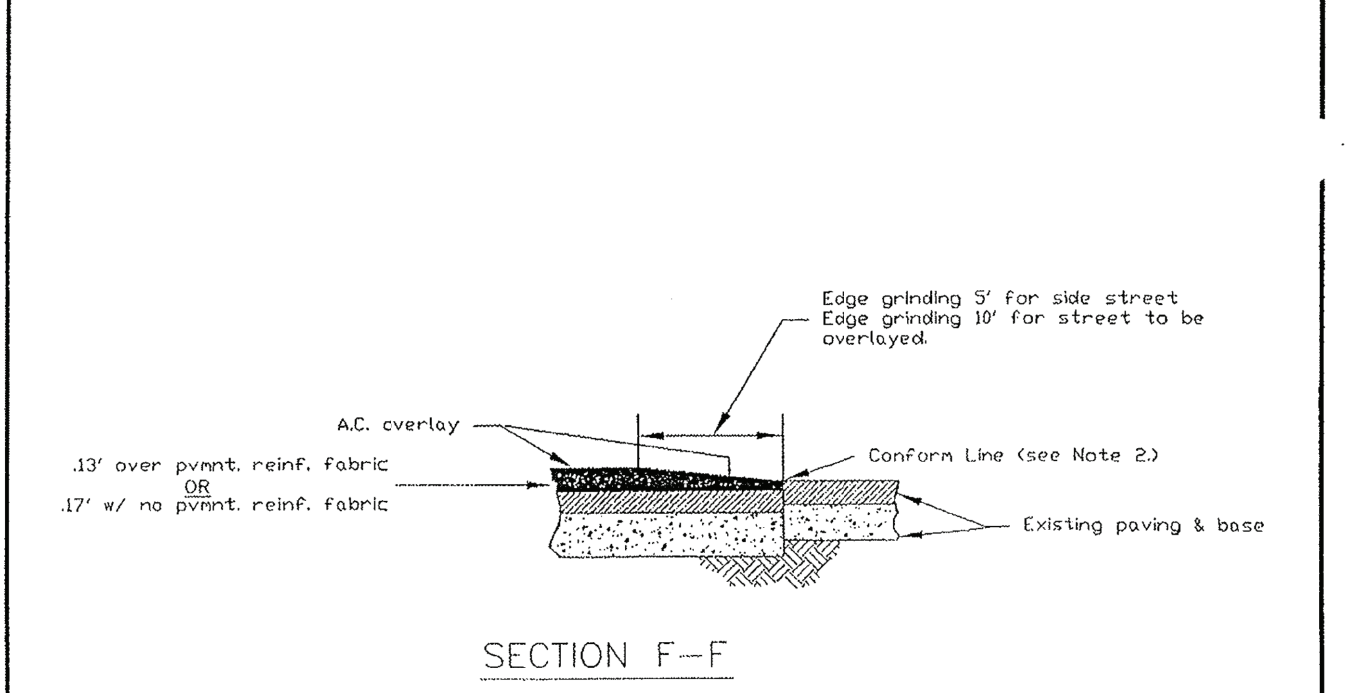
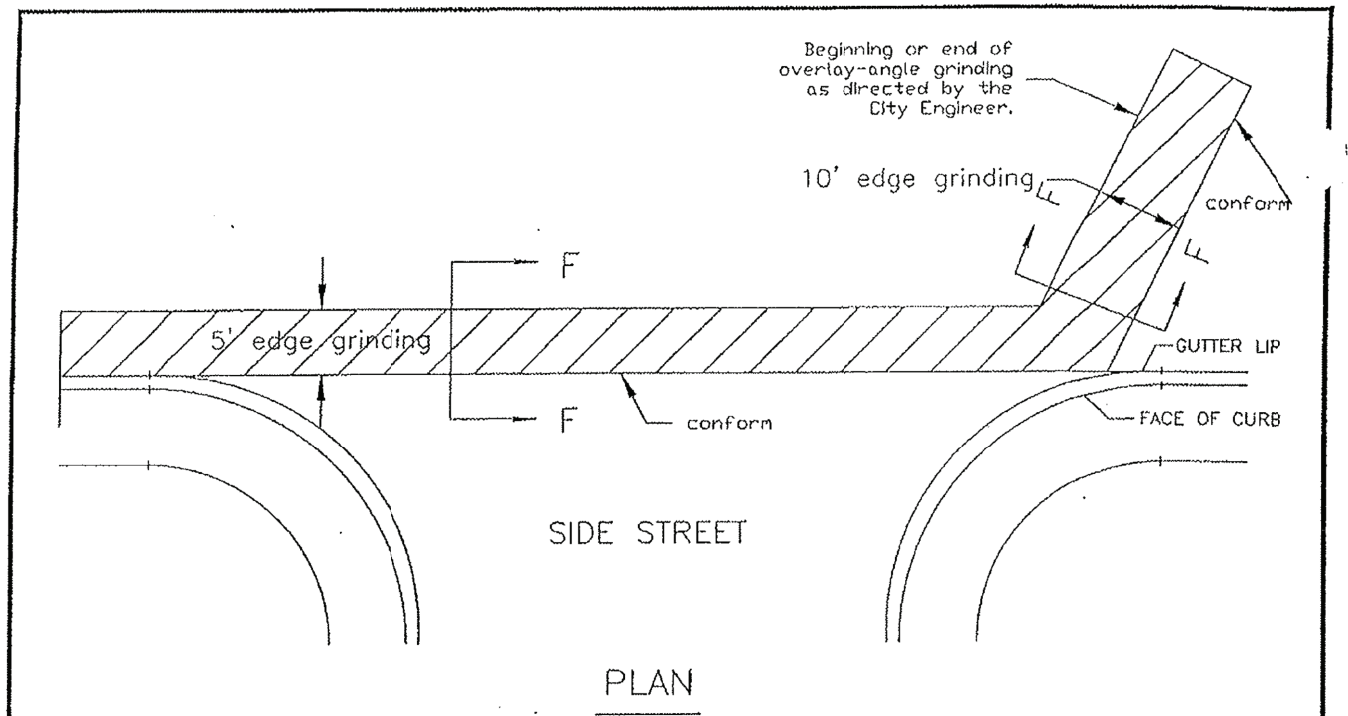

CITY OF ROHNERT PARK
 SIDE STREET AND END OF OVERLAY CONFORM
 SCALE: NONE DATE: JANUARY 2006
 Approved: [Signature] STD. - 208

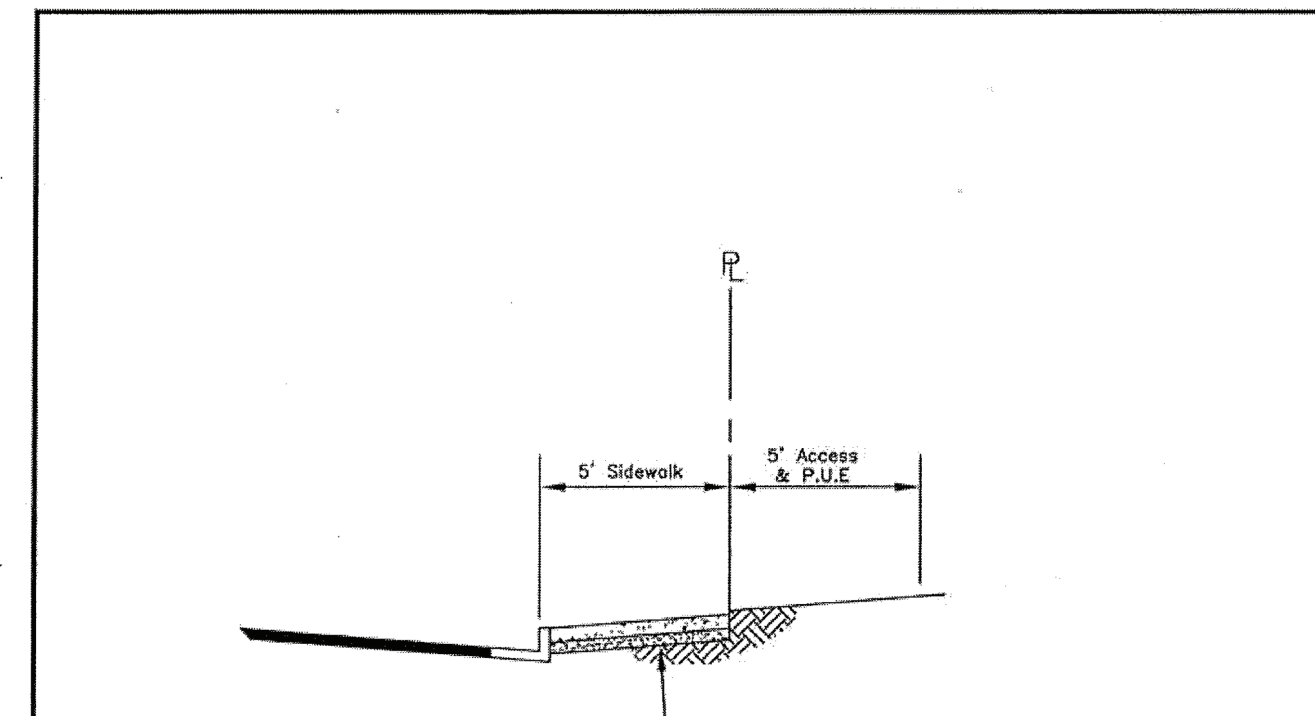

- NOTES:**
- MEANDERING SIDEWALKS AND PLANTER STRIPS TO BE REVIEWED ON A CASE-BY-CASE BASIS PER CITY ENGINEER OR PLANNING COMMISSION.
 - SCORING PATTERN SHOULD MATCH ADJOINING SIDEWALKS.

CITY OF ROHNERT PARK
 SIDEWALK AND EASEMENT DIMENSIONS FOR LANES, MINOR STREETS, AVENUES, NEIGHBORHOOD STREETS, AND INDUSTRIAL STREETS
 SCALE: NONE DATE: OCTOBER 2010
 Approved: [Signature] STD. - 230A

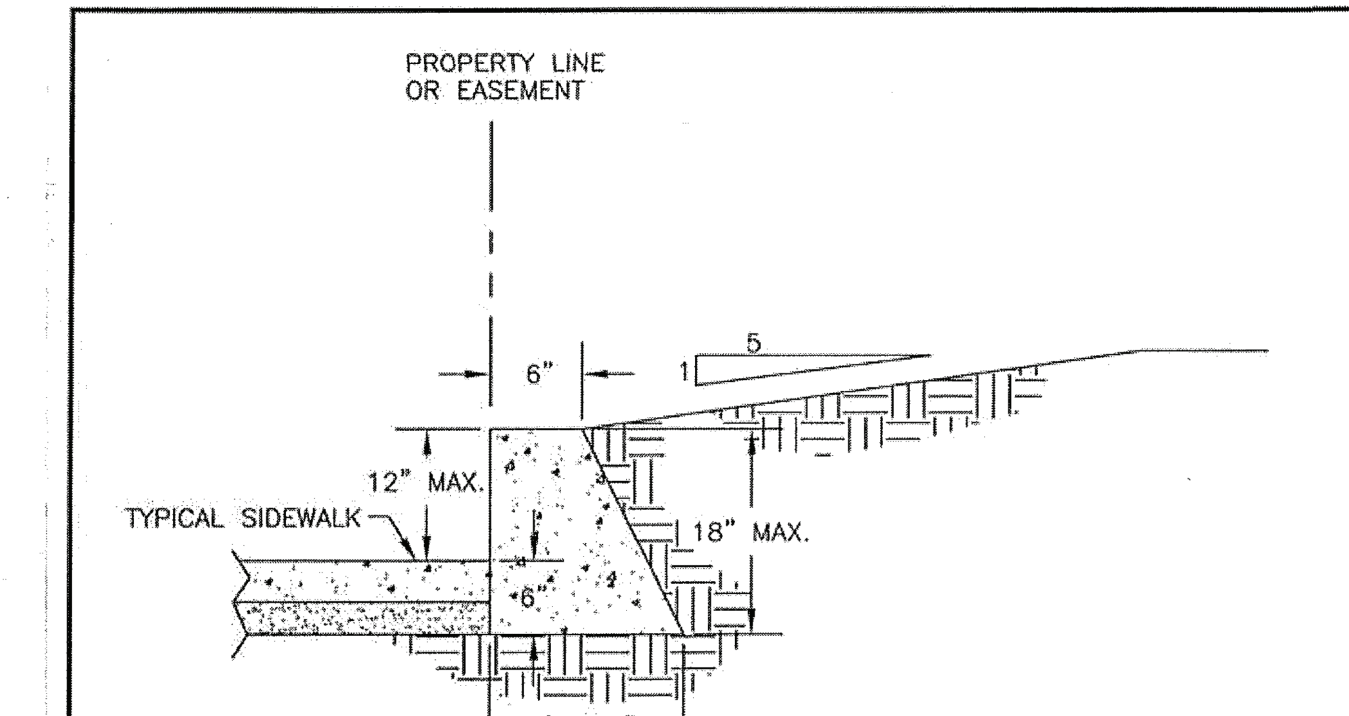

- NOTES:**
- IN FLATLAND AREAS, MAX SLOPE OF GROUND TO BE 5:1 OR FLATTER AS DIRECTED BY THE CITY ENGINEER.
 - RETAINING WALL TO BE INSTALLED AS PER DIRECTION AND ONLY WITH APPROVAL OF CITY ENGINEER.
 - RETAINING WALL IN HILLSIDES TO BE DESIGNED TO MEET APPROPRIATE STRUCTURAL REQUIREMENTS AND AS APPROVED BY THE CITY ENGINEER.

CITY OF ROHNERT PARK
 BACK OF SIDEWALK CONFORMS
 SCALE: NONE DATE: OCTOBER 2010
 Approved: [Signature] STD. - 233

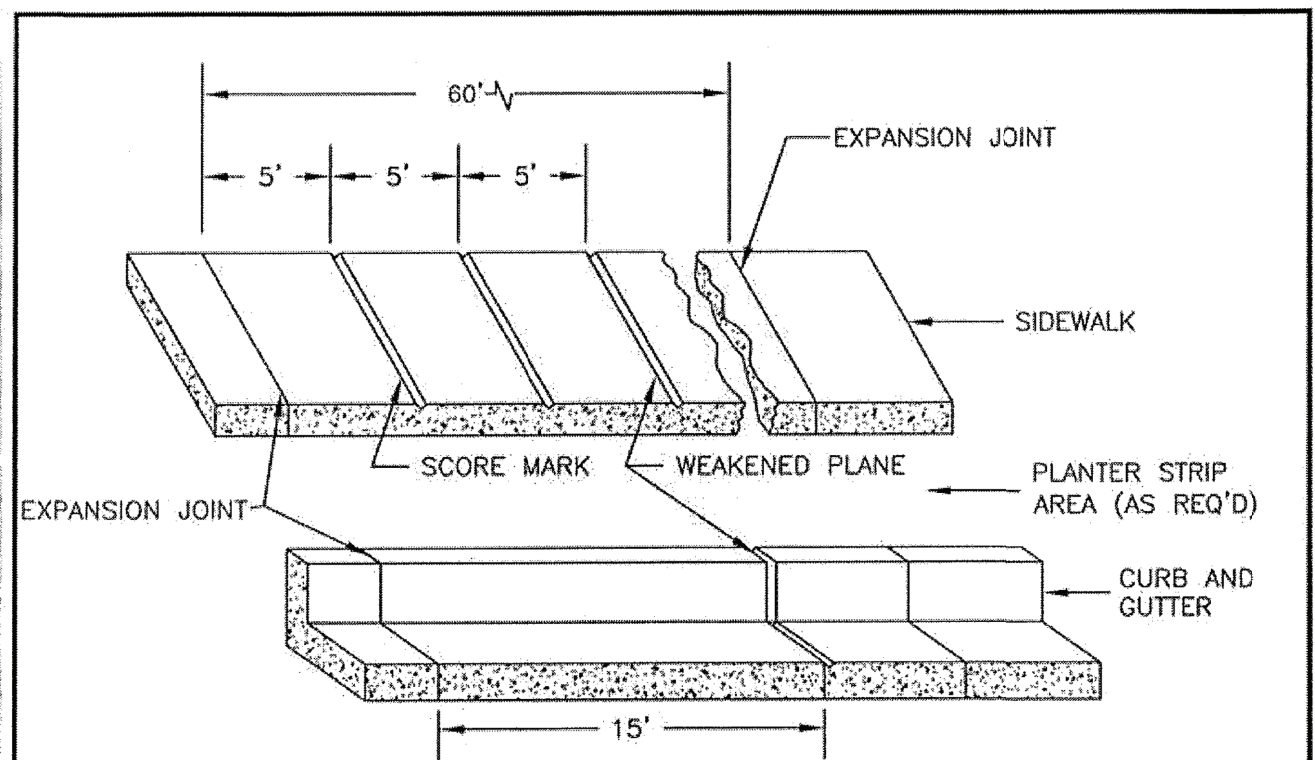

- NOTES:**
- WEAKENED PLANE: 1/8" WIDE x 1" DEEP IN SIDEWALKS, 1/8" WIDE x 1 1/2" DEEP IN CURB AND GUTTER.
 - EXPANSION JOINTS MATERIAL TO BE 1/4" THICK PREMOLDED JOINT FILLER FULL THICKNESS OF CONCRETE. APPROVED MECHANICAL JOINTS MAY BE USED IN WALKS IN LIEU OF EXPANSION JOINTS.
 - SCORE MARKS FOR SIDEWALKS 6' & MORE IN WIDTH: LONGITUDINAL SCORE MARK ALONG CENTER OF WALK.
 - EXPANSION JOINTS SHALL BE INSTALLED IN THE CURB & GUTTER AT ALL CURB RETURNS.
 - EXPANSION JOINTS SHALL BE PLACED IN THE SIDEWALK AT THE SAME LOCATION AS THOSE IN THE CURB & GUTTER WHEN THE SIDEWALK IS CURB ADJACENT, UNLESS OTHERWISE DIRECTED BY THE CITY ENGINEER.
 - SIDEWALK SHALL HAVE 4" BASE MATERIAL (CLASS II AGGREGATE BASE ROCK OR SAND), 4" OF P.C.C., AND HAVE A 2% SLOPE TOWARDS THE STREET.
 - SCORING PATTERN SHOULD MATCH ADJOINING SIDEWALKS.

CITY OF ROHNERT PARK
 TYPICAL SPACING - WEAKENED PLANES, SCORE MARKS, AND EXPANSION JOINTS
 SCALE: NONE DATE: OCTOBER 2010
 Approved: [Signature] STD. - 235

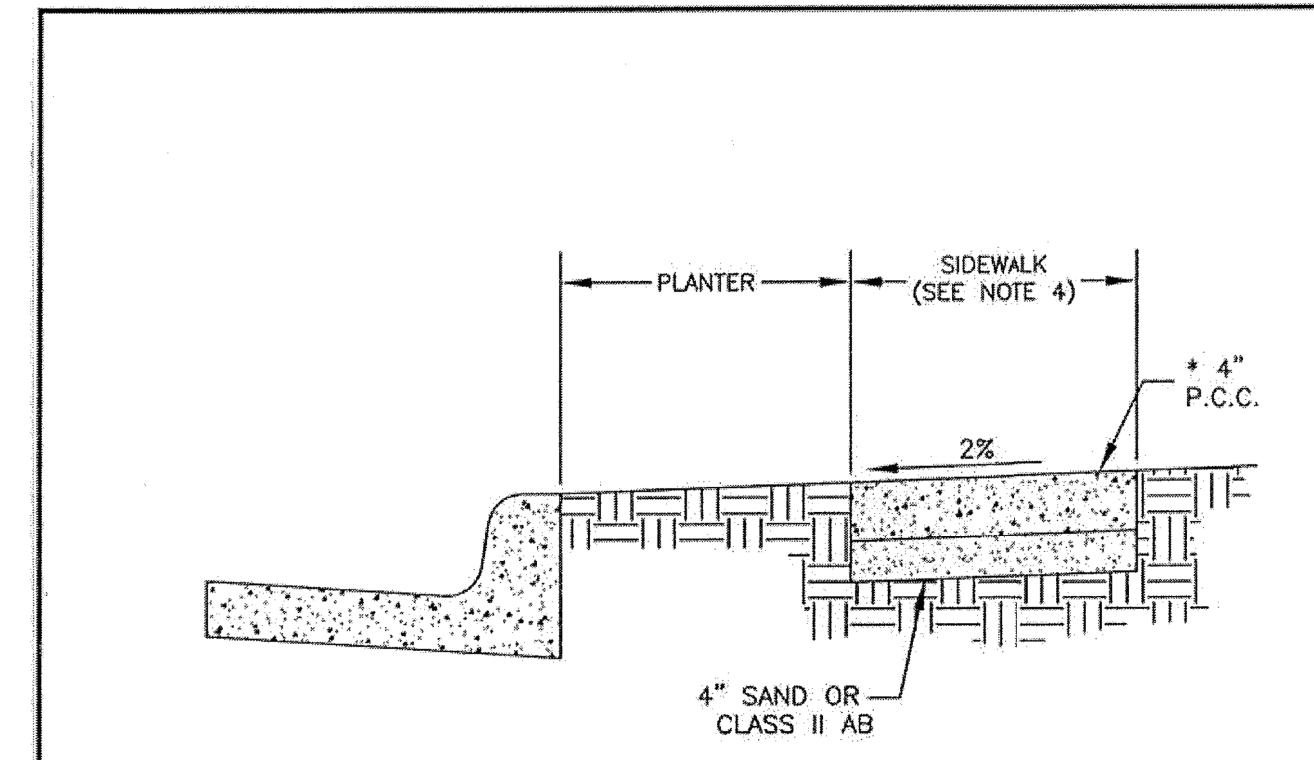

- NOTES:**
- JOINTS AND SCORING PER STD.-235.
 - ALL CONCRETE SHALL BE CLASS A P.C.C.
 - 6" FOR DRIVEWAY AREA.
 - SIDEWALK WIDTH SHALL MATCH EXISTING (UNLESS OTHERWISE CONDITIONED) AND SHALL MEANDER OR WIDEN AT OBSTRUCTIONS TO PROVIDE CLEARANCES AS SHOWN IN CITY STD.- 231.
 - DESIGN SHALL CONFORM TO THESE REQUIREMENTS EXCEPT AS OTHERWISE APPROVED BY THE CITY ENGINEER.

CITY OF ROHNERT PARK
 REPLACEMENT OF EXISTING SIDEWALK
 SCALE: NONE DATE: OCTOBER 2010
 Approved: [Signature] STD. - 237

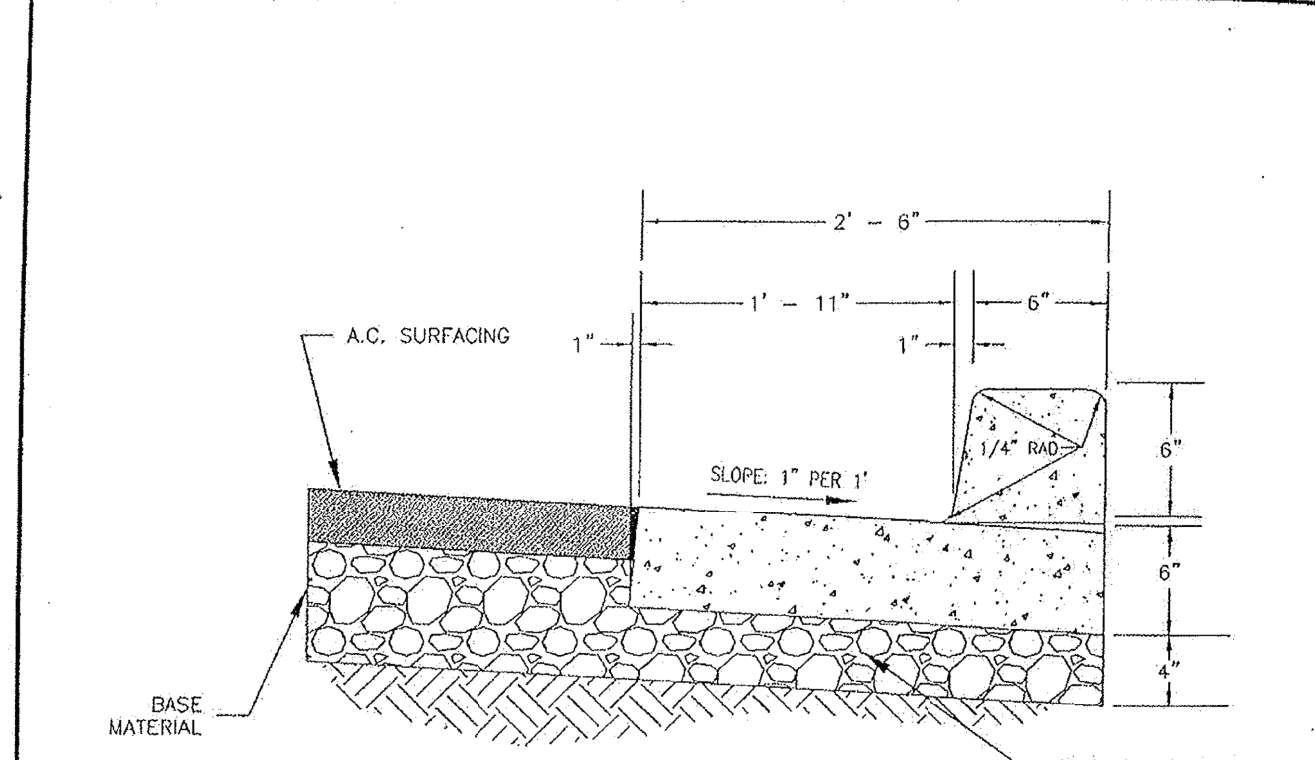

- NOTES:**
- SEE CITY STD.-235 FOR LOCATION OF WEAKENED PLANE AND EXPANSION JOINTS.
 - ALL CONCRETE SHALL BE CLASS "A" P.C.C.

CITY OF ROHNERT PARK
 CURB AND GUTTER
 SCALE: NONE DATE: JANUARY 2006
 Approved: [Signature] STD. - 241

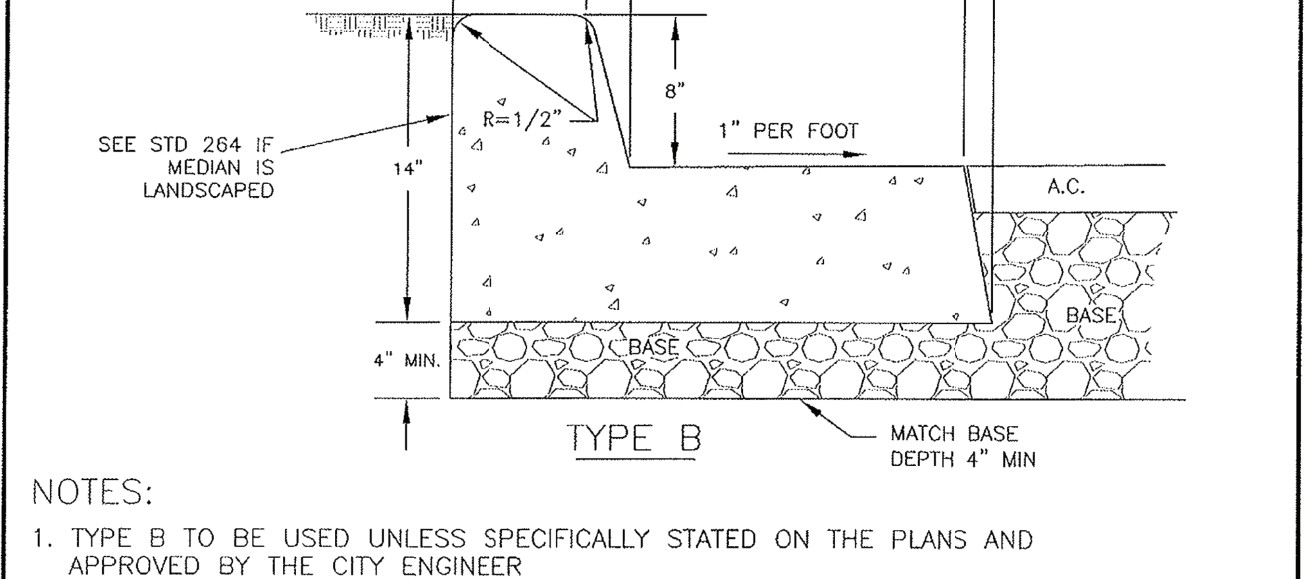
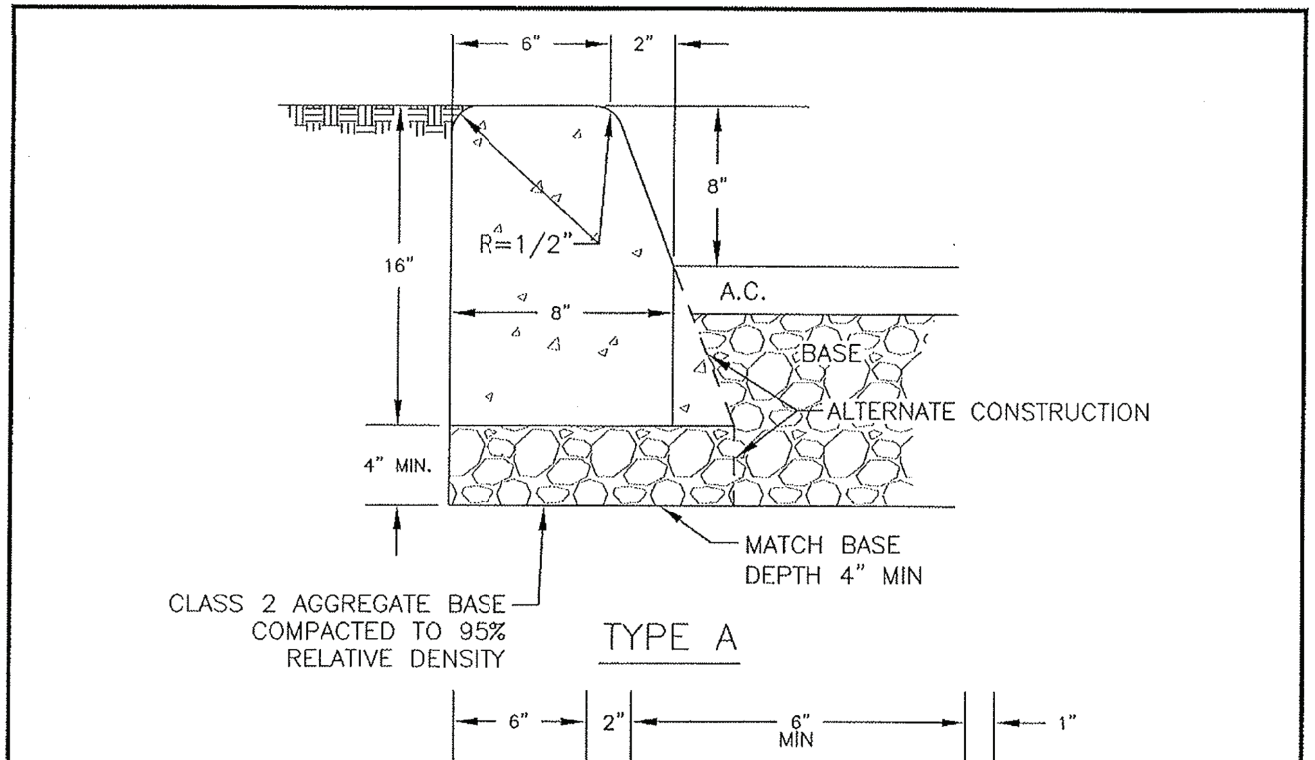

- NOTES:**
- TYPE B TO BE USED UNLESS SPECIFICALLY STATED ON THE PLANS AND APPROVED BY THE CITY ENGINEER.
 - SEE CITY STD.-235 FOR LOCATION OF WEAKENED PLANES AND EXPANSION JOINTS.
 - THESE DETAILS APPLY TO NEW CONSTRUCTION AND RECONSTRUCTION PROJECTS ONLY. MEDIAN CURB TO BE DETAILED ON PLANS WHERE INSTALLED ON EXISTING PAVEMENT.
 - ALL CONCRETE SHALL BE CLASS "A" P.C.C.
 - WHERE THE MEDIAN ISLAND IS TO BE PAVED, THE MEDIAN AND THE CURBS ARE TO BE POURED AS A UNIT (NO COLD JOINT).

CITY OF ROHNERT PARK
 STREET MEDIAN CURB
 SCALE: NONE DATE: OCTOBER 2010
 Approved: [Signature] STD. - 242

APPROVED FOR CONSTRUCTION:
 [Signature] 11/29/2023
 VANESSA MARIN GARRETT, R.C.E. 84141 DATE
 CITY ENGINEER, CITY OF ROHNERT PARK
 LICENSE EXPIRES SEPTEMBER 30, 2025

No.	Revisions

Date: NOV 2023
 Scale: AS SHOWN
 Design: NR
 Drawn: KSD
 Approved: AJD
 App. No: 20212283
 Drawing Number:

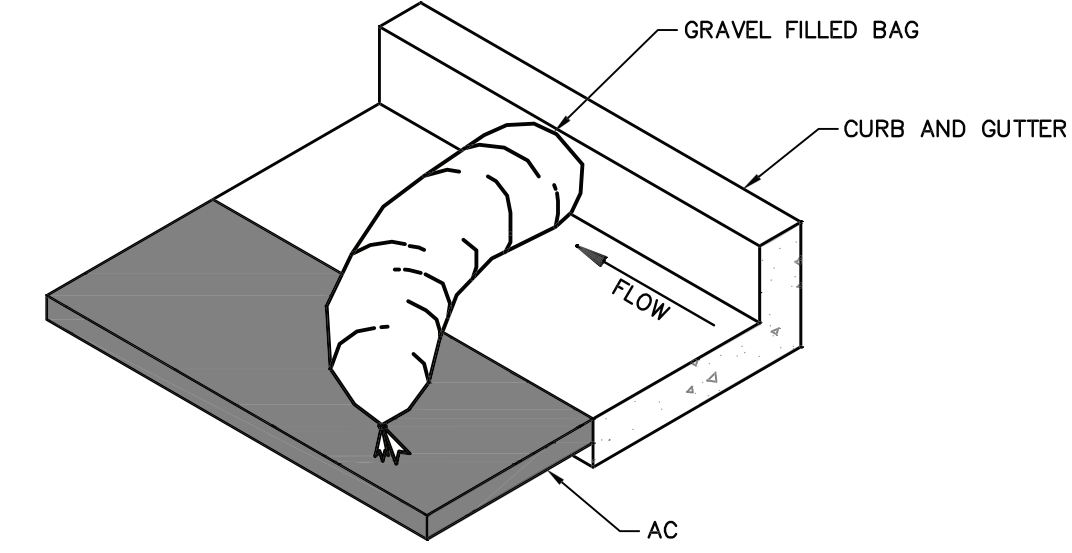
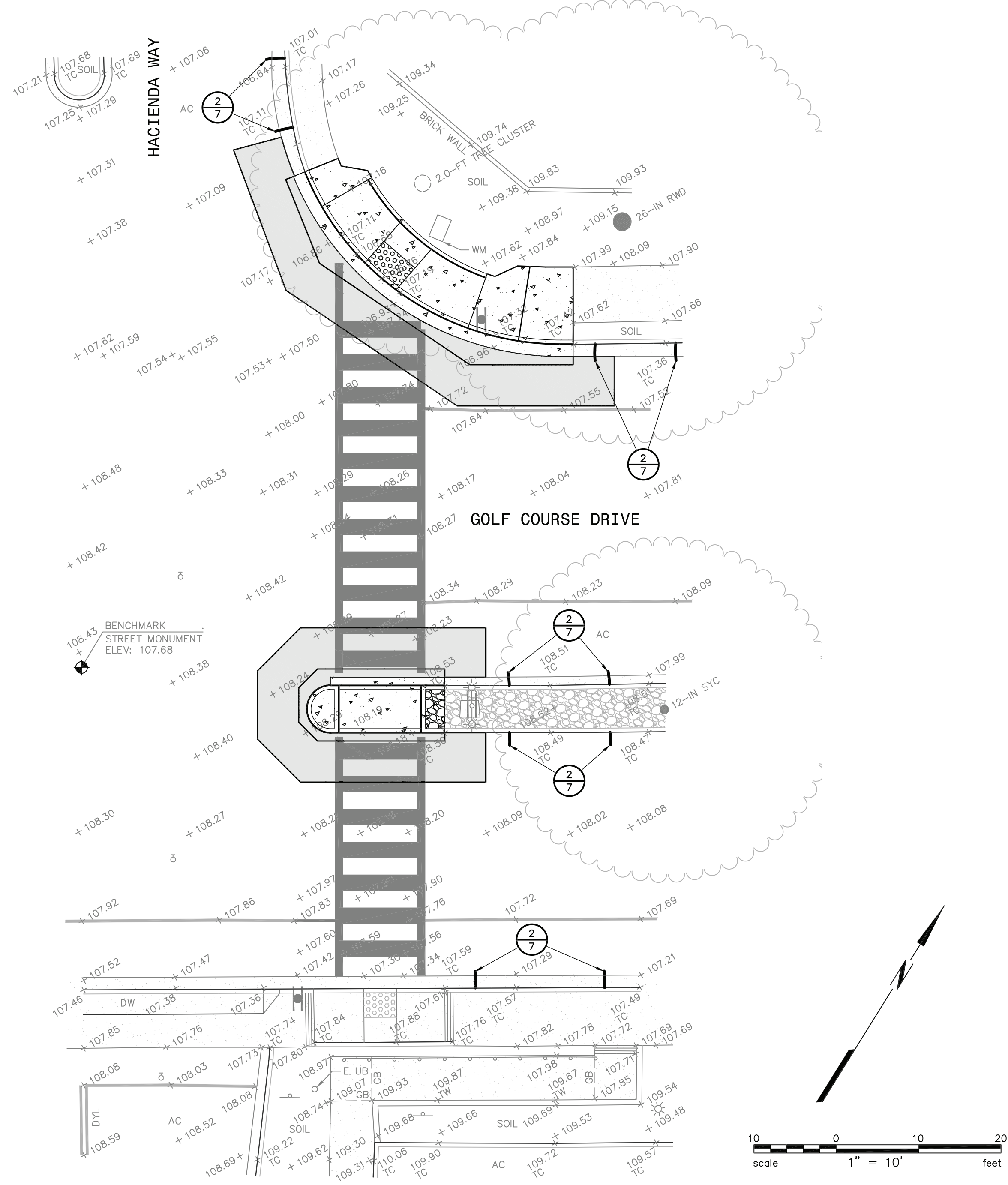

2 GRAVEL BAG DETAIL
NO SCALE

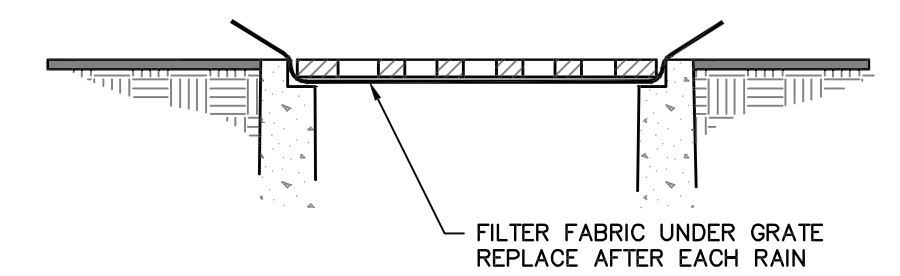

3 FILTER FABRIC DETAIL
NO SCALE

SEDIMENT CONTROL NOTES

EROSION AND SEDIMENT CONTROL MEASURES SHOWN ON THESE DRAWINGS ARE GENERAL IN NATURE AND MAY NOT BE APPLICABLE DURING CERTAIN PHASES OF CONSTRUCTION. THE CRUSHED ROCK ENTRANCE DETAIL SHOWN ON THESE DRAWINGS REFLECTS A CONDITION PRIOR TO SURFACES BEING PAVED, WHEREAS FILTERS AT STORM WATER INLETS REFLECTS A CONDITION AFTER THE STORM DRAIN SYSTEM HAS BEEN INSTALLED.

THE CONTRACTOR SHALL INTEGRATE APPROPRIATE MEASURES DURING EACH CONSTRUCTION PHASE TO ENSURE THAT SEDIMENT AND OTHER POLLUTANTS DO NOT ENTER THE STORM DRAIN SYSTEM.

THE CONTRACTOR SHALL USE WATER OR DUST PALLIATIVE TO MINIMIZE WIND EROSION. THE CONTRACTOR SHALL DESIGNATE AN AREA ON SITE TO STOCKPILE MATERIAL. THE STOCKPILED MATERIAL SHALL BE COVERED AT ALL TIMES TO PREVENT EROSION FROM WIND, RAIN AND STORM WATER RUNOFF.

EROSION AND SEDIMENT CONTROL MEASURES SHALL BE PLACED IN FRONT OF INCOMPLETE STORM DRAIN SYSTEMS TO PREVENT DEBRIS AND SEDIMENT-LADEN WATER FROM ENTERING INTO THE PUBLIC STORM DRAIN SYSTEM. BEST MANAGEMENT PRACTICES SHALL BE USED WHEN INSTALLING SUCH DEVICES.

THE CONTRACTOR SHALL BE RESPONSIBLE FOR CONSTANT MAINTENANCE OF EROSION AND SEDIMENT CONTROL MEASURES AT ALL TIMES TO THE SATISFACTION OF THE CITY OF ROHNERT PARK. EROSION AND SEDIMENT CONTROL MEASURES AND THEIR INSTALLATION SHALL BE ACCOMPLISHED USING BEST MANAGEMENT PRACTICES.

IF THE STORM DRAIN SYSTEM IS NOT INSTALLED PRIOR TO A PRECIPITATION EVENT, ADDITIONAL MEASURES SHALL BE TAKEN SUCH AS TEMPORARY SETTLING BASINS WHICH MEET THE SATISFACTION OF THE CITY OF ROHNERT PARK. SILT AND/OR CATCH BASINS MUST BE CLEANED OUT ON A REGULAR BASIS AFTER STORMS TO MAINTAIN DESIGN CAPACITY.

STORM WATER RUNOFF FROM THE CONSTRUCTION SITE SHALL BE DIRECTED TOWARD AN INLET WITH A SEDIMENT OR FILTRATION INTERCEPTOR PRIOR TO ENTERING THE STORM DRAIN SYSTEM.

THE CONTRACTOR WILL BE RESPONSIBLE FOR CLEANING WATER THAT HAS BECOME POLLUTED DUE TO NOT TAKING NECESSARY EROSION AND SEDIMENT CONTROL ACTIONS.

THE CONTRACTOR SHALL BE RESPONSIBLE FOR CLEANUP OF MUD AND DEBRIS CARRIED ON TO SURROUNDING STREETS AND AS A RESULT OF CONSTRUCTION ACTIVITY ON THE SITE TO THE SATISFACTION OF THE CITY OF ROHNERT PARK.

ANY DENUDE OR DISTURBED SOILS SHALL BE PROTECTED USING BEST MANAGEMENT PRACTICES.

PRIOR TO AND DURING A PRECIPITATION EVENT, ALL PAVED AREAS WILL BE KEPT CLEAR OF EARTH MATERIAL AND DEBRIS. THE SITE IS TO BE MAINTAINED BY THE CONTRACTOR SO THAT A MINIMUM OF SEDIMENT-LADEN RUNOFF LEAVES THE SITE.

THE CONTRACTOR SHALL INFORM ALL CONSTRUCTION SITE WORKERS ABOUT THE MAJOR PROVISIONS OF THE EROSION AND SEDIMENT CONTROL PLAN AND SEEK THEIR COOPERATION IN AVOIDING THE DISTURBANCE OF THESE CONTROL MEASURES.

BEST MANAGEMENT PRACTICES SHALL BE VISUALLY MONITORED ON A WEEKLY BASIS DURING THE DRY SEASON AND RECORDED IN AN INSPECTION CHECKLIST. RAIN EVENT VISUAL MONITORING SHALL BE PERFORMED WITHIN 48 HOURS PRIOR TO AN ANTICIPATED RAIN EVENT, DAILY DURING A RAIN EVENT AND WITHIN 48 HOURS FOLLOWING A RAIN EVENT. REMOVE SEDIMENTS WHEN ACCUMULATIONS REACH 1/3 THE HEIGHT OF THE BARRIER AND REPLACE FILTER DEVICES AS NECESSARY TO ENSURE PROPER FUNCTION.

UNSTABILIZED AREAS WILL BE REPAIRED AS SOON AS POSSIBLE AFTER BEING DAMAGED.

ALL GRADED OR DISTURBED AREAS SHALL BE STABILIZED IMMEDIATELY AFTER GRADING IS COMPLETE.

ENTRANCE TO THE PROJECT SHALL BE MAINTAINED IN A CONDITION THAT WILL PREVENT TRACKING OR FLOWING OF SEDIMENT INTO PUBLIC RIGHT-OF-WAY. WHEN NECESSARY, WHEELS SHALL BE CLEANED TO REMOVE SEDIMENT PRIOR TO ENTRANCE OF PUBLIC RIGHTS-OF-WAY. WHEN WASHING IS REQUIRED IT SHALL BE DONE IN AN AREA STABILIZED WITH CRUSHED ROCK THAT DRAINS INTO A SEDIMENT TRAP.

ALL SEDIMENT SPILLED, DROPPED, OR TRACKED ONTO PUBLIC RIGHTS-OF-WAY SHALL BE REMOVED IMMEDIATELY USING BEST MANAGEMENT PRACTICES.

ALL EROSION AND SEDIMENT CONTROL MEASURES SHALL BE REMOVED WHEN THEY HAVE SERVED THEIR PURPOSE SO AS NOT TO BLOCK OR IMPEDE STORM FLOW OR DRAINAGE.

ALL EROSION AND SEDIMENT CONTROL MEASURES SHALL BE REPAIRED OR REPLACED WHEN THEY ARE NO LONGER FUNCTIONING.

THE CONTRACTOR SHALL HAVE EROSION AND SEDIMENT CONTROL MEASURES ON SITE ADEQUATE TO PROTECT THE ENTIRE SITE SUCH THAT IT IS IMMEDIATELY AVAILABLE IN PREPARATION OF A PRECIPITATION EVENT.

THE CONTRACTOR SHALL DISPOSE OF UNUSED CONSTRUCTION MATERIALS AND WASTE PRIOR TO THE COMPLETION OF CONSTRUCTION.

AFTER CONSTRUCTION IS COMPLETE ALL STORM DRAIN SYSTEMS ASSOCIATED WITH THIS PROJECT SHALL BE INSPECTED AND CLEARED OF ACCUMULATED SEDIMENTS AND DEBRIS.

GRADED AREAS TO BE SEED FOR EROSION CONTROL SHALL USE GRASS SEED AT THE RATE OF 75-100 LBS. PER ACRE. SEEDING AREAS SHALL BE IRRIGATED TO ENSURE COVER IS ESTABLISHED PRIOR TO THE RAINY SEASON.

HYDROSEED SHALL BE EITHER APPLIED MECHANICALLY OR BY HYDROSEEDING. HYDROSEEDING REQUIRES THE APPLICATION OF FIBER AND STABILIZING EMULSION. MECHANICAL APPLICATION SHALL REQUIRE ROLLING, TAMPING, OR OTHERWISE WORKING THE SEED APPROXIMATELY 0.5 INCHES INTO THE TOPSOIL.

STABILIZATION OF EXPOSED GRADED AREAS WITH STRAW MULCH SHALL BE APPLIED AT A RATE OF 2 TONS PER ACRE.

APPROVED FOR CONSTRUCTION:

 11/29/2023 DATE
 VANESSA MARIN GARRETT, R.C.E. 84141
 CITY ENGINEER, CITY OF ROHNERT PARK
 LICENSE EXPIRES SEPTEMBER 30, 2025

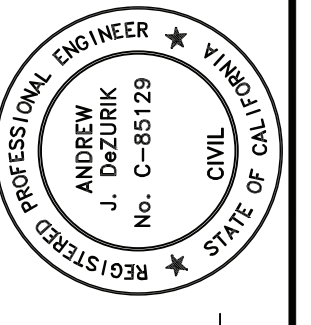

11/15/2023
 ANDREW J. DEZURIK
 C 85129

BKF ENGINEERS
 200 4th STREET
 SUITE 300
 SAN ANTONIO, CA 95401
 (707) 583-8500
 www.bkf.com

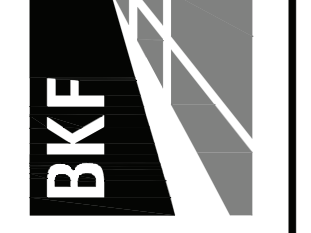

PEDESTRIAN RAMP IMPROVEMENTS
 GOLF COURSE DRIVE AT HACIENDA WAY
 ROHNERT PARK, CALIFORNIA
EROSION & SEDIMENT CONTROL PLAN

Revisions	No.	Date	By	Appr.

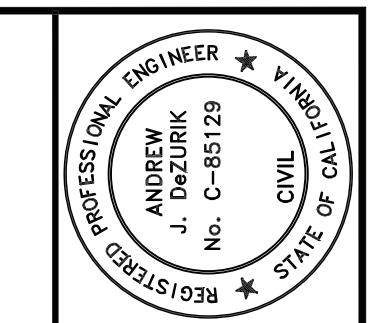

11/15/2023
ANDREW J. DEZURIK
C 85129

BKF ENGINEERS
200 4th STREET
SUITE 300
SAN JOSE, CA 95101
(707) 583-8500
www.bkf.com

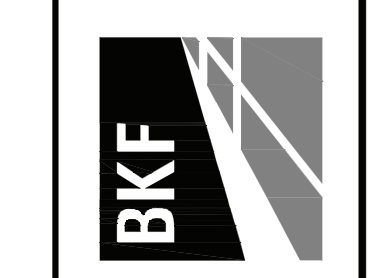

PEDESTRIAN RAMP IMPROVEMENTS
GOLF COURSE DRIVE AT HALCYON PLACE
ROHNERT PARK, CALIFORNIA

EROSION & SEDIMENT CONTROL PLAN

Revisions	No.	Date	By	App. No.

APPROVED FOR CONSTRUCTION:

Vanessa Marin Garrett 11/29/2023
 VANESSA MARIN GARRETT, R.C.E. 84141 DATE
 CITY ENGINEER, CITY OF ROHNERT PARK
 LICENSE EXPIRES SEPTEMBER 30, 2025

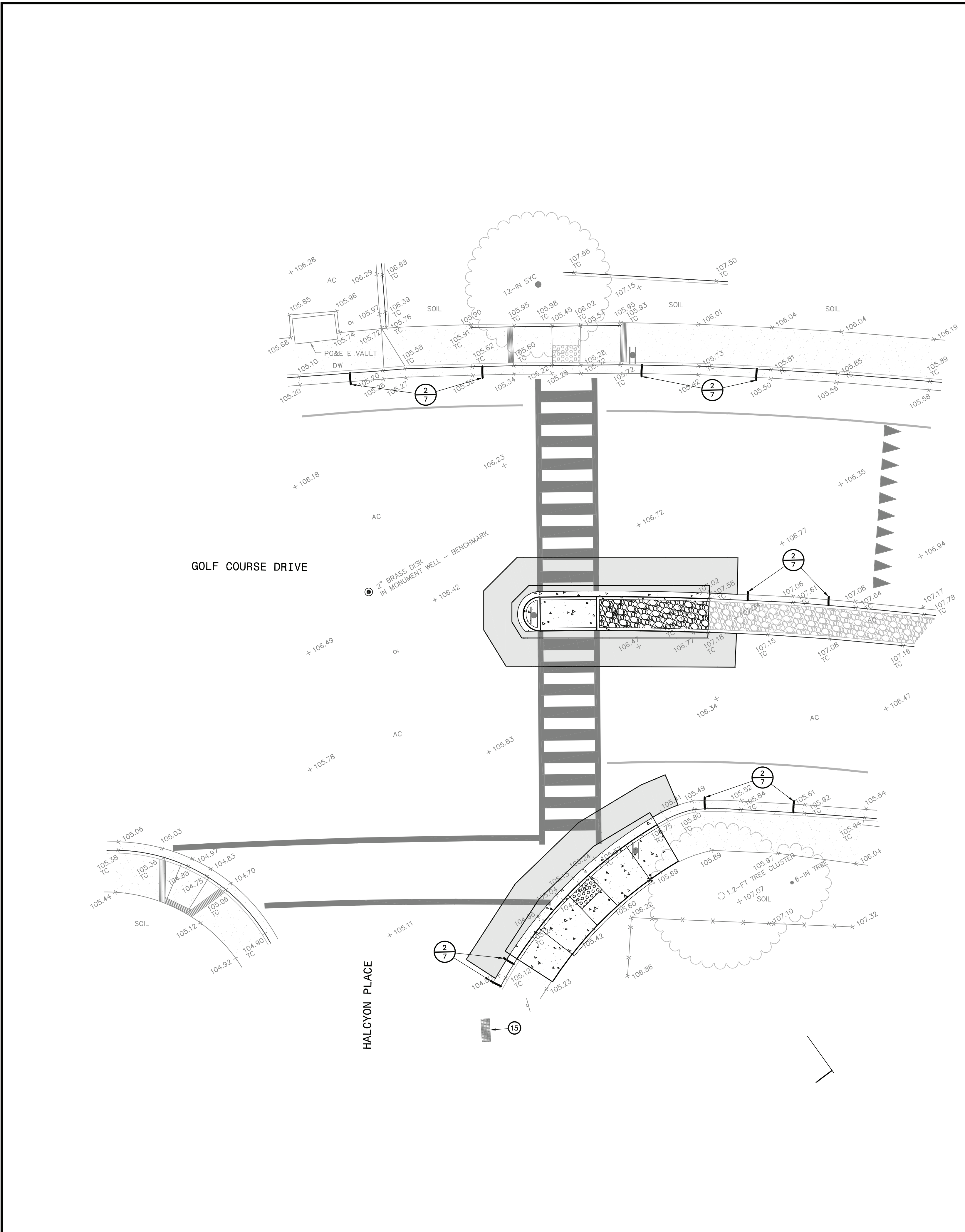

- KEYNOTES**
- 15 CONTRACTOR TO ADD INLET PROTECTION AS SHOWN ON DETAIL 3, SHEET 7 AT NEAREST DOWNSTREAM INLET.

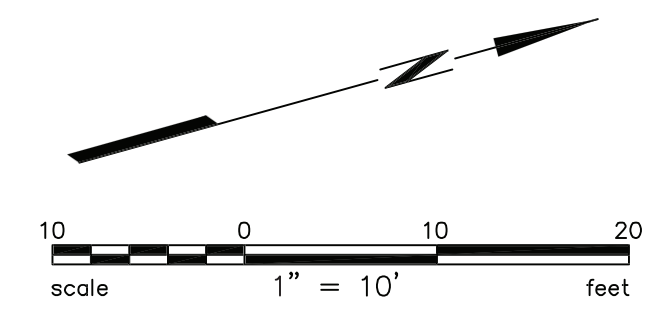

GENERAL NOTES:

1. ALL STRIPING SHALL CONFORM TO THE CITY OF ROHNERT PARK STANDARD PLANS, THE 2022 EDITION OF THE CALTRANS DEPARTMENT OF TRANSPORTATION (CALTRANS) STANDARD SPECIFICATIONS (AND REVISIONS), STANDARD PLANS (AND REVISIONS), AND THE CALIFORNIA MANUAL ON UNIFORM TRAFFIC CONTROL DEVICES (MUTCD) 2014 REVISION 6 (EFFECTIVE 3/30/21).
2. ALL SIGNAGE SHALL CONFORM TO THE CA MUTCD 2014 REVISION 6.
3. ALL PAVEMENT MARKINGS SHALL BE THERMOPLASTIC.
4. CONTRACTOR SHALL PROTECT IN PLACE EXISTING SIGNAGE AND STRIPING UNLESS OTHERWISE NOTED ON THE PLAN.
5. CONTRACTOR TO REMOVE USA MARKS AND SPRAY PAINT FROM CONCRETE.

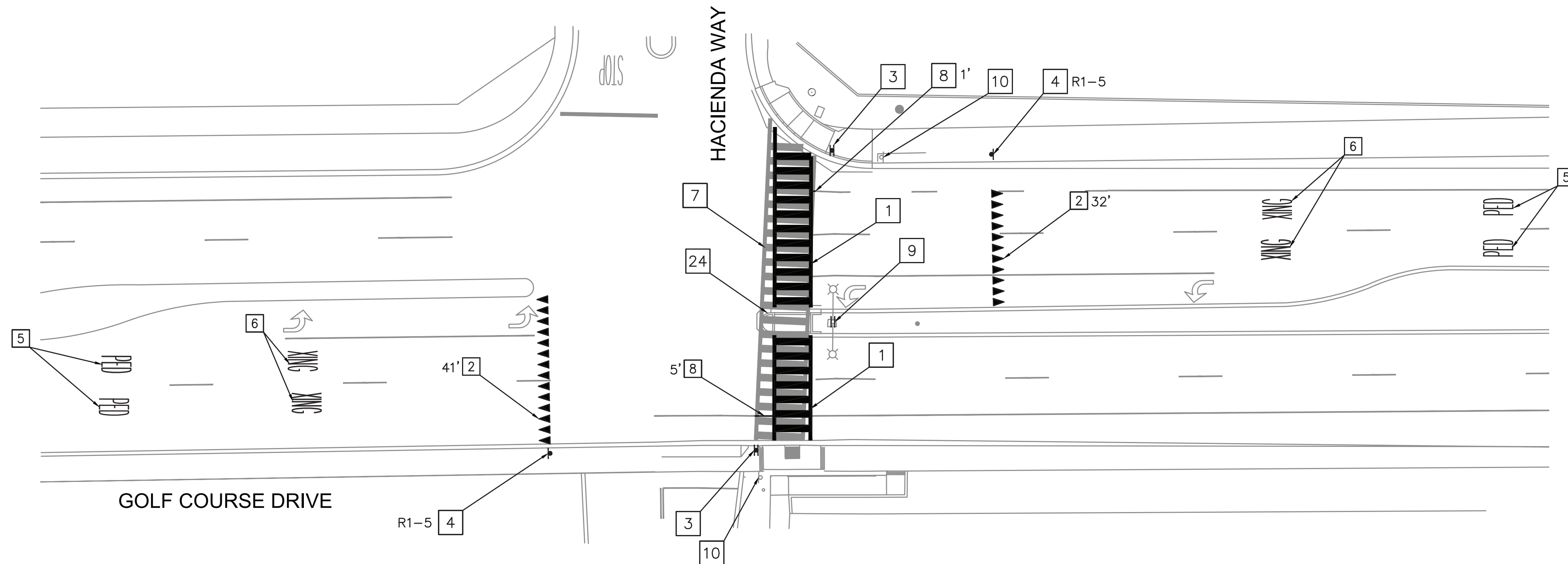

CONSTRUCTION NOTES:

- 1] INSTALL NEW LADDER CROSSWALK PER CALTRANS STANDARD DETAIL A24F. LONGITUDINAL CROSSWALK MARKINGS SHALL BE 2' WIDE, WITH 2' SPACING BETWEEN THEM. LATERAL CROSSWALK MARKINGS SHALL BE 1' WIDE.
- 2] INSTALL NEW YIELD LINE PER REVISED CALTRANS STANDARD DETAIL RSP A24G.
- 3] FURNISH AND INSTALL NEW DOUBLE-SIDED RRFB ASSEMBLY ON NEW POLE IN ACCORDANCE WITH DETAIL 1 ON SHEET 11.
- 4] FURNISH AND INSTALL NEW SIGN ON NEW SIGN POST PER ROHNERT PARK STANDARD DETAIL 705B.
- 5] RESTRIPE EXISTING "PED" PAVEMENT MARKING. MATCH EXISTING COLOR.
- 6] RESTRIPE EXISTING "XING" PAVEMENT MARKING. MATCH EXISTING COLOR.
- 7] REMOVE EXISTING LADDER CROSSWALK AS SHOWN.
- 8] INSTALL NEW CHANNELIZING LINE PER DETAIL 38A ON REVISED CALTRANS STANDARD DETAIL RSP A20D.
- 9] REMOVE AND SALVAGE EXISTING SIGNS. FURNISH AND INSTALL NEW DOUBLE-SIDED RRFB ASSEMBLY ON EXISTING LUMINAIRE POLE IN ACCORDANCE WITH DETAIL 2 ON SHEET 11.
- 24] INSTALL MEDIAN ISLAND TREATMENT PER CITY OF ROHNERT PARK STANDARD DETAIL 721.

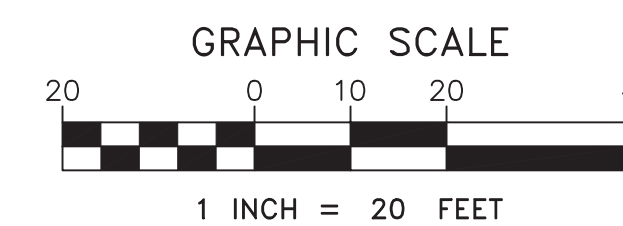

APPROVED FOR CONSTRUCTION:
Vanessa Marin Garrett 11/29/2023
 VANESSA MARIN GARRETT, R.C.E. 84141 DATE
 CITY ENGINEER, CITY OF ROHNERT PARK
 LICENSE EXPIRES SEPTEMBER 30, 2025

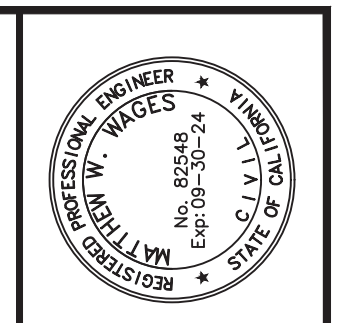

MATTHEW W. WAGES
 11-17-2023
 C 82548

iteris
 1992 Member of State #225
 Phone: (714) 940-7847

CITY OF ROHNERT PARK GOLF COURSE DRIVE PEDESTRIAN IMPROVEMENTS
 SIGNING AND STRIPING PLAN
 GOLF COURSE DRIVE @ HACIENDA WAY

Revisions	No.	Date	Design	Drawn	Approved	Project No.
		NOV 2023	KXR	KXR	MWW	2019-28

Drawing Number:
 SS-01
 9 OF 11

GENERAL NOTES:

1. ALL STRIPING SHALL CONFORM TO THE CITY OF ROHNERT PARK STANDARD PLANS, THE 2022 EDITION OF THE CALTRANS DEPARTMENT OF TRANSPORTATION (CALTRANS) STANDARD SPECIFICATIONS (AND REVISIONS), STANDARD PLANS (AND REVISIONS), AND THE CALIFORNIA MANUAL ON UNIFORM TRAFFIC CONTROL DEVICES (MUTCD) 2014 REVISION 6 (EFFECTIVE 3/30/21).
2. ALL SIGNAGE SHALL CONFORM TO THE CA MUTCD 2014 REVISION 6.
3. ALL PAVEMENT MARKINGS SHALL BE THERMOPLASTIC.
4. CONTRACTOR SHALL PROTECT IN PLACE EXISTING SIGNAGE AND STRIPING UNLESS OTHERWISE NOTED ON THE PLAN.
5. CONTRACTOR TO REMOVE USA MARKS AND SPRAY PAINT FROM CONCRETE.

CONSTRUCTION NOTES:

1. INSTALL NEW LADDER CROSSWALK PER CALTRANS STANDARD DETAIL A24F. LONGITUDINAL CROSSWALK MARKINGS SHALL BE 2' WIDE, WITH 2' SPACING BETWEEN THEM. LATERAL CROSSWALK MARKINGS SHALL BE 1' WIDE.
2. INSTALL NEW YIELD LINE PER REVISED CALTRANS STANDARD DETAIL RSP A24G.
3. FURNISH AND INSTALL NEW DOUBLE-SIDED RRFB ASSEMBLY ON NEW POLE IN ACCORDANCE WITH DETAIL 1 ON SHEET 11.
4. FURNISH AND INSTALL NEW SIGN ON NEW SIGN POST PER ROHNERT PARK STANDARD DETAIL 705B.
5. RESTRIPE EXISTING "PED" PAVEMENT MARKING. MATCH EXISTING COLOR.
6. RESTRIPE EXISTING "XING" PAVEMENT MARKING. MATCH EXISTING COLOR.
7. REMOVE EXISTING LADDER CROSSWALK AS SHOWN.
10. REMOVE AND SALVAGE EXISTING SIGNS AND SIGN POST COMPLETE.
11. RESTRIPE EXISTING CROSSWALK. MATCH EXISTING TYPE AND COLOR.
12. REMOVE EXISTING YIELD LINE MARKINGS.
22. REMOVE AND SALVAGE EXISTING SIGNS.
23. REMOVE EXISTING SIGN POST. RELOCATE EXISTING SIGN AND OBJECT MARKER TO NEW SIGN POST AT NEW MEDIAN NOSE.
24. INSTALL MEDIAN ISLAND TREATMENT PER CITY OF ROHNERT PARK STANDARD DETAIL 721.

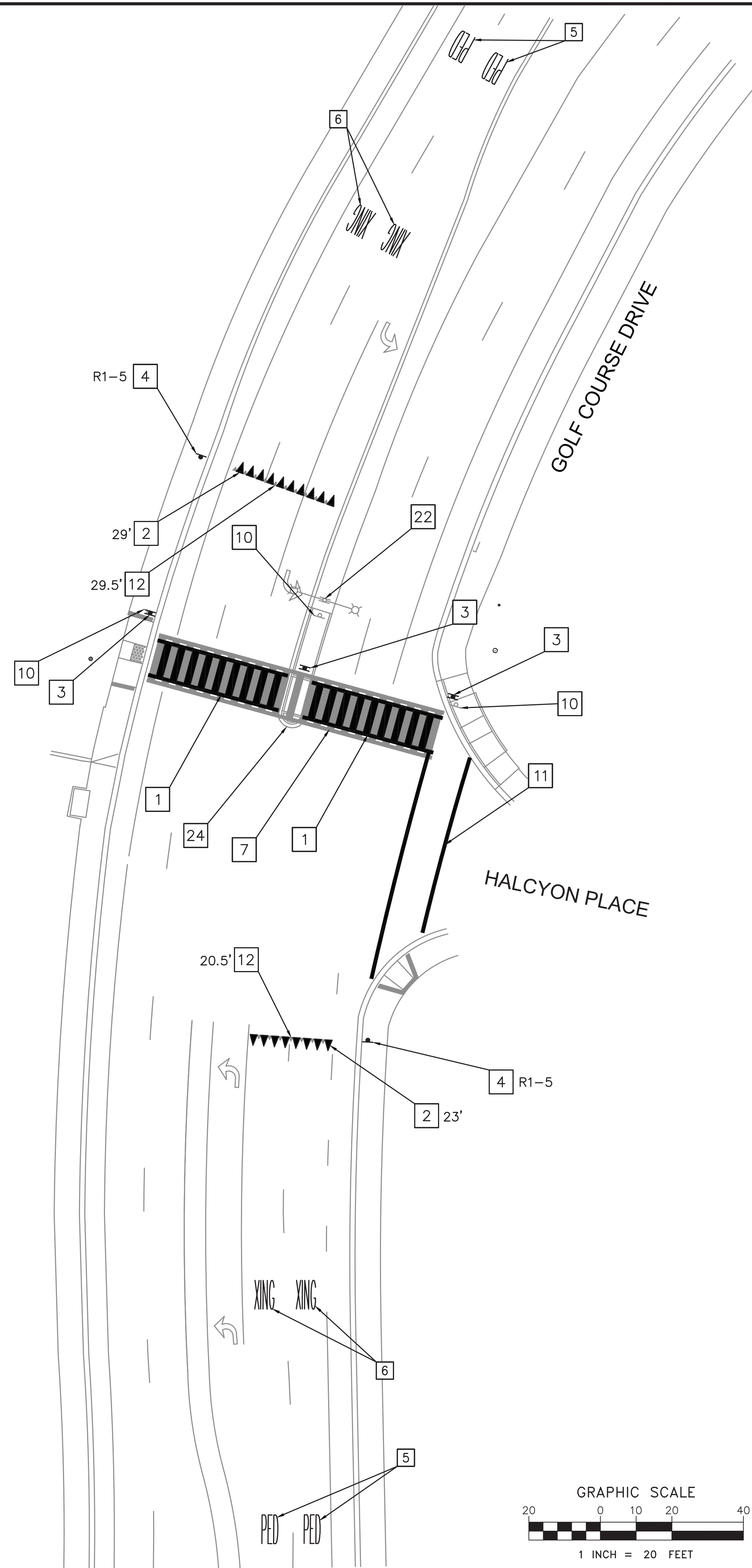

APPROVED FOR CONSTRUCTION:
Vanessa Marin Garrett 11/29/2023
 VANESSA MARIN GARRETT, R.C.E. 84141
 CITY ENGINEER, CITY OF ROHNERT PARK
 LICENSE EXPIRES SEPTEMBER 30, 2025

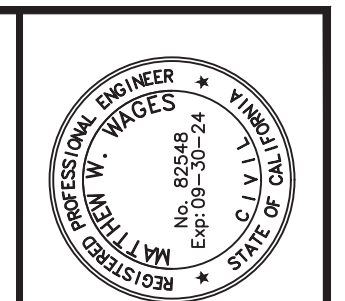

11-17-2023
 MATTHEW W. WAGES
 C 82548

iteris
 1992 Member of State #2125
 Phone: (714) 940-7847

CITY OF ROHNERT PARK GOLF COURSE DRIVE PEDESTRIAN IMPROVEMENTS
 SIGNING AND STRIPING PLAN
 GOLF COURSE DRIVE @ HALCYON PLACE

Revisions	No.	Date	Scale	Design	Drawn	Approved	Project
		NOV 2023	1"=20'	KXR	KXR	MWW	2019-28

Drawing Number: SS-02
 10 OF 11



R1-5

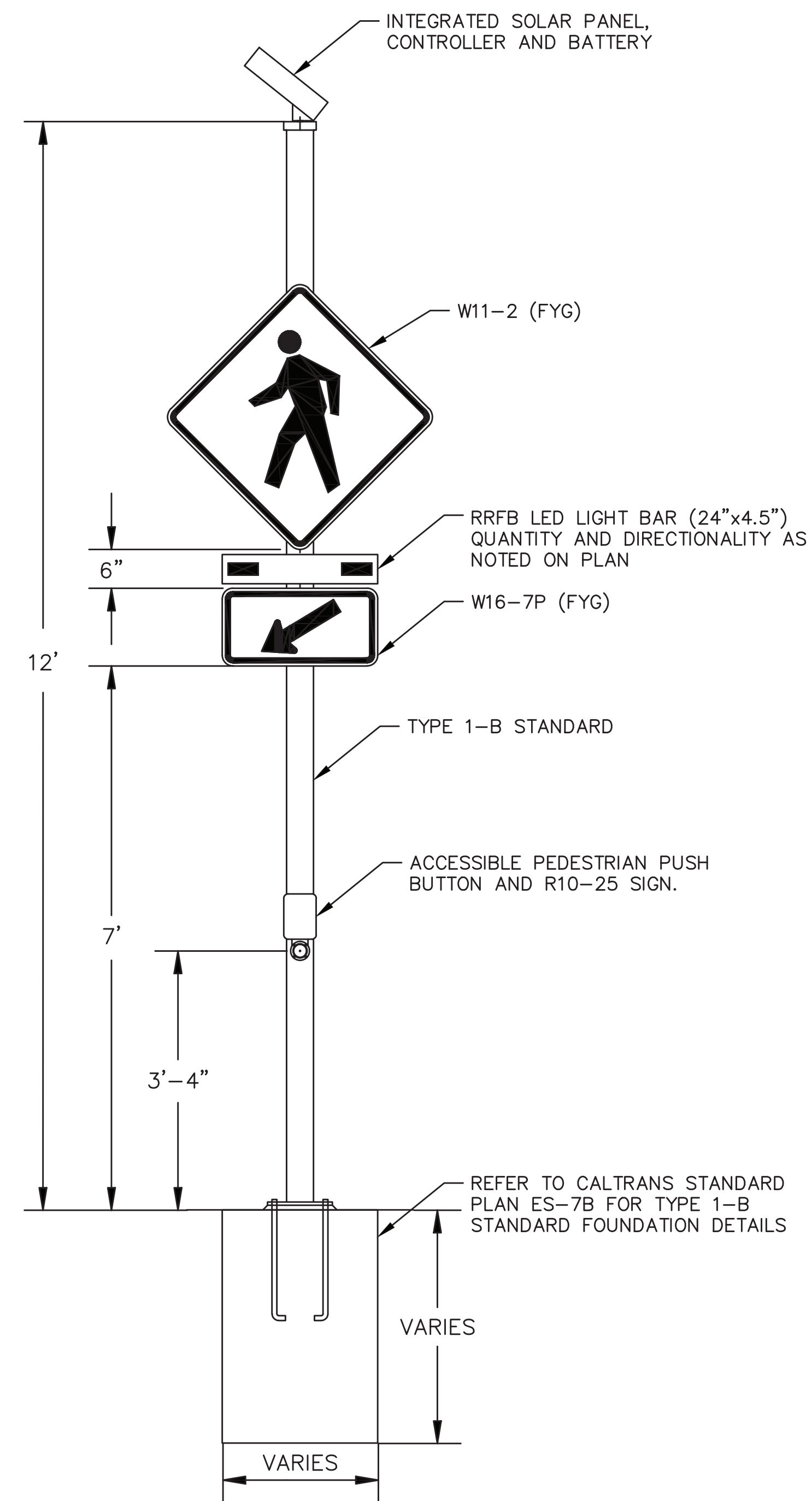

NOTE: DOUBLE-SIDE ASSEMBLIES INCLUDE TWO OF EACH SIGN AND RRFB LED BAR

1 RRFB ASSEMBLY ON NEW POST
N.T.S.

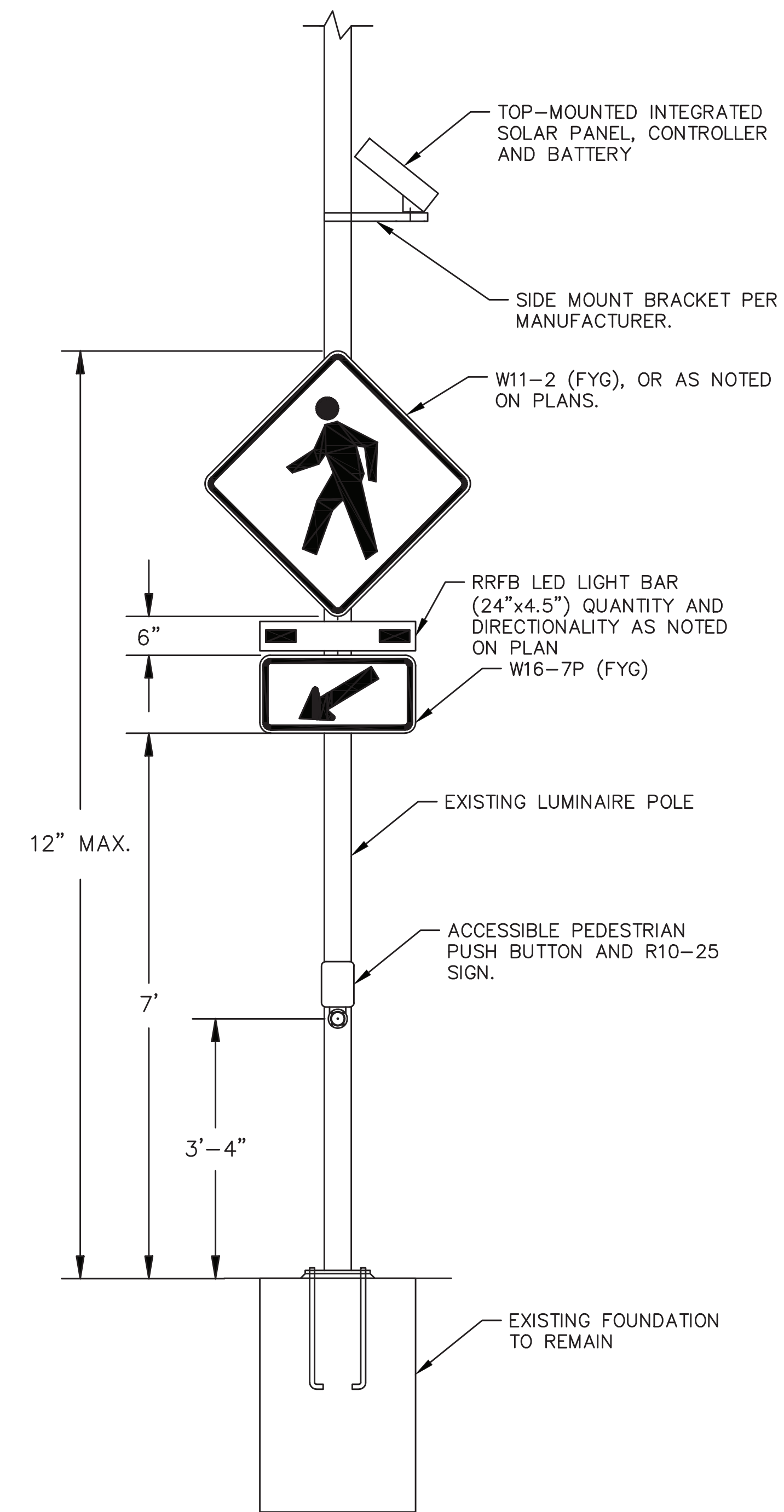

NOTE: DOUBLE-SIDE ASSEMBLIES INCLUDE TWO OF EACH SIGN AND RRFB LED BAR

2 RRFB ASSEMBLY ON EXISTING LUMINAIRE (SIDE-MOUNT)
N.T.S.

APPROVED FOR CONSTRUCTION:

 11/29/2023
 VANESSA MARIN GARRETT, R.C.E. 84141
 CITY ENGINEER, CITY OF ROHNERT PARK
 LICENSE EXPIRES SEPTEMBER 30, 2025

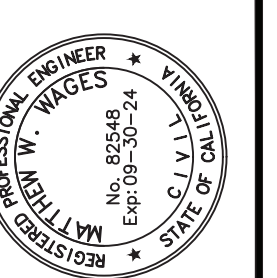

10/19/2023
 MATTHEW W. WAGES
 C. 82548

iteris
 1999 Member of State #2125
 Phone: 610.740.7847

CITY OF ROHNERT PARK GOLF COURSE DRIVE PEDESTRIAN IMPROVEMENTS

SIGNING AND STRIPING DETAILS

Revisions	No.	Date	Scale	Design	Drawn	Approved	Project
		OCT 2023	N/A	KXR	KXR	MWW	2019-28

Drawing Number:
DT-03
11 OF 11